

WORLD
AQUATICS

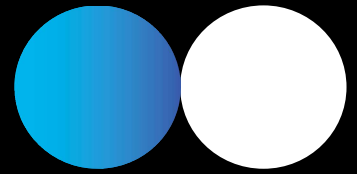

SWIMMING

COMPETITION
REGULATIONS

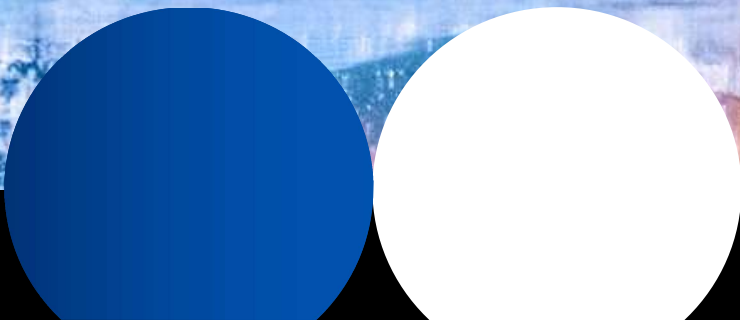



TABLE OF CONTENTS

PART TWO: SWIMMING RULES

PART TWO: SWIMMING RULES	69
1 MANAGEMENT OF COMPETITIONS	69
2 OFFICIALS.....	71
3 SEEDING OF HEATS, SEMI-FINALS AND FINALS	74
4 THE START.....	76
5 FREESTYLE	76
6 BACKSTROKE.....	76
7 BREASTSTROKE.....	77
8 BUTTERFLY	77
9 MEDLEY SWIMMING	78
10 THE RACE	78
11 TIMING	79
12 WORLD RECORDS.....	79
13 AUTOMATIC OFFICIATING PROCEDURE	81
14 AGE GROUP RULES – SWIMMING.....	82
15 SWIMWEAR AND WEARABLES.....	82
16 SWIMMING FACILITIES AND EQUIPMENT.....	82
17 MEDICAL AND SAFETY SPECIFIC REQUIREMENT FOR SWIMMING.....	95



PART TWO: SWIMMING RULES

1 MANAGEMENT OF COMPETITIONS

- 1.1** The Management Committee appointed by the governing body shall have jurisdiction over all matters not assigned by the rules to the referee, judges or other officials and shall have power to postpone events and give directions consistent with rules adopted for conducting any event.
- 1.2** Organisers of swimming competitions shall appoint sufficient officials to ensure the fairness, integrity and safety of the competition.
- 1.2.1** At the Olympic Games, the World Aquatics Championships, and the World Aquatics Swimming Championships (25m), the following minimum number of officials for the control of the competition shall be appointed:
- Referee (2)
 - Starters (2)
 - Judges of Stroke (4)
 - Chief Inspector of Turns (2)
 - Inspectors of Turns (16/20 + 2 reserves)
 - Control Room Supervisor (1)
 - Video Review Supervisor (1)
 - Video Review judges (4/5)
 - Call Room Supervisor (1)
 - Call room judges (4/5)
 - Resolution Desk judge
 - Warm-up supervisor(s)
- 1.2.2** For all other international competitions, the governing body shall appoint the same or fewer number of officials, subject to the approval of the respective regional or international authority where appropriate.
- 1.2.3** Where Automatic Officiating Equipment is not available, such equipment must be replaced by a chief timekeeper. Wherever possible, a minimum of one (1) timekeeper per lane shall be appointed together with one (1) additional timekeeper in case of a watch malfunction. It is advisable that there shall be three (3) timekeepers for each lane.
- 1.2.4** Finish judges may be used when Automatic Equipment and/or watches are not used.
- 1.3** The swimming pool and the technical equipment for Olympic Games and World Aquatics Championships shall be inspected and approved prior to the Swimming competitions by the World Aquatics Delegate together with a member of the Technical Swimming Committee.
- 1.4** Where underwater video equipment is used by television, the equipment must be operated by remote control and shall not obstruct the vision or path of swimmers and must not change the configuration of the pool or obscure the required World Aquatics markings.
- 1.5** The event management shall specify for heats, semi-finals, and finals the presentation and preparation protocol that the competitors must respect when they leave the final call-room.
- 1.6** **Program of World Aquatics and Olympic Games Swimming Competitions**

1.6.1 Program of the Olympic Games

	Men	Women
Freestyle	50m, 100m, 200m 400m, 800m, 1500m	50m, 100m, 200m 400m, 800m, 1500m
Backstroke	100m, 200m	100m, 200m
Breaststroke	100m, 200m	100m, 200m
Butterfly	100m, 200m	100m, 200m
Individual Medley	200m, 400m	200m, 400m
Relays: Freestyle	4x100m, 4x200m	4x100m, 4x200m
Relays: Medley	4x100m	4x100m
Mixed Relays	4x100m Medley	

Only entry times achieved in 50m pools will be accepted. Heats and semi-finals may be swum using 10 lanes. Finals should be swum using 8 lanes.

1.6.2 Program of the World Aquatics Championships (50m)

	Men	Women
Freestyle	50m, 100m, 200m 400m, 800m, 1500m	50m, 100m, 200m 400m, 800m, 1500m
Backstroke	50m, 100m, 200m	50m, 100m, 200m
Breaststroke	50m, 100m, 200m	50m, 100m, 200m
Butterfly	50m, 100m, 200m	50m, 100m, 200m
Individual Medley	200m, 400m	200m, 400m
Relays: Freestyle	4x100m, 4x200m	4x100m, 4x200m
Relays: Medley	4x100m	4x100m
Mixed Relays	4x100m Freestyle and 4x100m Medley	

Only entry times achieved in 50m pools will be accepted. Heats and semi-finals may be swum using 10 lanes. Finals should be swum using 8 lanes.

1.6.3 Program of World Aquatics Swimming Championships (25m)

	Men	Women
Freestyle	50m, 100m, 200m 400m, 800m, 1500m	50m, 100m, 200m 400m, 800m, 1500m
Backstroke	50m, 100m, 200m	50m, 100m, 200m
Breaststroke	50m, 100m, 200m	50m, 100m, 200m
Butterfly	50m, 100m, 200m	50m, 100m, 200m
Individual Medley	100m, 200m, 400m	100m, 200m, 400m
Relays: Freestyle	4x50m, 4x100m 4x200m	4x50m, 4x100m 4x200m
Relays: Medley	4x50m, 4x100m	4x50m, 4x100m
Mixed Relays	4x50m Freestyle and 4x50m Medley	



Entry times achieved in 25m and 50m pools will be accepted. Heats and semi-finals may be swum using 10 lanes. Finals should be swum using 8 lanes.

1.6.4 Program of the World Aquatics Junior Swimming Championships

	Men	Women
Freestyle	50m, 100m, 200m 400m, 800m, 1500m	50m, 100m, 200m 400m, 800m, 1500m
Backstroke	50m, 100m, 200m	50m, 100m, 200m
Breaststroke	50m, 100m, 200m	50m, 100m, 200m
Butterfly	50m, 100m, 200m	50m, 100m, 200m
Individual Medley	200m, 400m	200m, 400m
Relays: Freestyle	4x100m, 4x200m	4x100m, 4x200m
Relays: Medley	4x100m	4x100m
Mixed Relays	4x100m Freestyle and 4x100m Medley	

Only entry times achieved in 50m pools will be accepted. Heats and semi-finals may be swum using 10 lanes. Finals should be swum using 8 lanes.

1.6.5 Program of the World Aquatics Swimming World Cup

The program of the World Aquatics Swimming World Cup will be defined by World Aquatics on an annual basis.

2 OFFICIALS

2.1 Referee

2.1.1 The referee shall have full control and authority over all officials, approve their assignments, and instruct them regarding all special features or regulations related to the competitions. She/He shall enforce all rules and decisions of World Aquatics and shall decide all questions relating to the actual conduct of the meet, and event or the competition, the final settlement of which is not otherwise covered by the rules.

2.1.2 The referee may intervene in the competition at any stage to ensure that the World Aquatics regulations are observed, and shall adjudicate all protests related to the competition in progress.

2.1.3 When using finish judges without three (3) digital watches, the referee shall determine placing where necessary. Automatic Officiating Equipment, if available and operating shall be consulted as stated in Part Two, Article 13.

2.1.4 The referee shall ensure that all necessary officials are in their respective posts for the conduct of the competition. He/She may appoint substitutes for any who are absent, incapable of acting or found to be inefficient. He/She may appoint additional officials if considered necessary.

2.1.5 Once all swimmers have removed their clothing, except for swimwear, the Referee shall signal the commencement of an event by a short series of whistles inviting them to get ready at the starting end, followed by a long whistle indicating that they should take their positions on the starting platform (or for backstroke swimming and medley relays to immediately enter the water). A second long whistle shall bring the backstroke and medley relay swimmer immediately to the starting position. When the swimmers and officials are prepared for the start, the referee shall gesture to the starter with a stretched-out arm, indicating that the swimmers are under the starter's control. The stretched-out arm shall stay in that position until the start is given.

2.1.6 A disqualification for initiating the start before the starting signal must be observed and confirmed by both the Starter and the Referee. When Automatic Officiating Equipment is available, it may be used to verify the disqualification.

2.1.7 The referee shall disqualify any swimmer for any other violation of the rules that they personally observe. The referee may also disqualify any swimmer for any violation reported to him by other authorised officials. All disqualifications are subject to the decision of the referee.



2.1.8 All potential infractions shall be verbally reported to the Referee. Once confirmed by the Referee, a signed disqualification card shall be completed by the reporting official, detailing the event, lane number and the infraction.

2.1.9 The Referee shall appoint officials who shall determine, in relay events, whether the starting swimmer is in contact with the starting platform when the preceding swimmer touches the starting wall. When Automatic Officiating Equipment which judges relay take-offs is available, it shall be used in accordance with Part Two, Article 13.1.

2.2 Control Room Supervisor

2.2.1 The Control Room Supervisor shall supervise the operation of the Automatic Officiating Equipment.

2.2.2 The Control Room Supervisor is responsible for checking the results from computer printouts.

2.2.3 The Control Room Supervisor is responsible for checking the relay exchange printout and reporting any early take-offs to the referee.

2.2.4 The Control Room Supervisor may review the video timing to confirm early take-off.

2.2.5 The Control Room Supervisor shall

- control withdrawals after the heats and/or semi- finals,
- enter results on official forms,
- list all new records established, and
- maintain scores where appropriate.

2.3 Starter

2.3.1 The starter shall have full control of the swimmers from the time the referee turns the swimmers over to him (Part Two, Article 2.1.5) until the race has commenced. The start shall be given in accordance with Part Two, Article 4.

2.3.2 The starter shall report a swimmer to the referee for delaying the start, for willfully disobeying an order or for any other misconduct taking place at the start, but only the referee may disqualify a swimmer for such delay, willful disobedience or misconduct.

2.3.3 The starter shall have power to decide whether the start is fair, subject only to the decision of the Referee.

2.3.4 When starting an event, the starter shall stand on the side of the pool within approximately five metres of the starting edge of the pool where the timekeepers can see and or hear the starting signal and the swimmers can hear the signal.

2.3.5 The Starter shall report to the Referee any violation observed within their jurisdiction.

2.4 Call Room Supervisor

2.4.1 The Call Room Supervisor shall assemble swimmers prior to each event.

2.4.2 The Call Room Supervisor shall report to the Referee any violation noted with regard to:

- swimwear;
- advertising (Part One, Article 8 - Advertising Identification); and
- if a swimmer is not present when called.

2.5 Chief Inspector of Turns

2.5.1 The Chief Inspector of Turns shall ensure that inspectors of turns fulfil their duties during the competition.

2.6 Inspectors of Turns

2.6.1 One Inspector of Turns shall be assigned to each lane at each end of the pool, to ensure swimmers comply with the relevant rules after the start, for each turn, and at the finish.

2.6.2 Jurisdiction for the Inspector of Turns at the start end commences from the start signal until the completion of the first arm stroke, except in Breaststroke where it shall be the second arm stroke.



- 2.6.3** For each turn, jurisdiction for the Inspector of Turns commences from the beginning of the last arm stroke before touching and ending with the completion of the first arm stroke after the turn, except in Breaststroke where it shall be the second arm stroke.
- 2.6.4** Jurisdiction for the Inspector of Turns at the finish commences from the beginning of the last arm stroke before touching.
- 2.6.5** When a Backstroke ledge is being used, each inspector at the starting end shall install and remove the ledge. Once installed, the ledge shall be set at zero (0).
- 2.6.6** In individual events of 800 and 1500 metres, each Inspector of Turns at the start and turning end of the pool shall record the number of laps completed by the swimmer in his/her lane. The swimmers shall be informed of the remaining number of laps to be completed by displaying "lap cards" showing odd numbers at the turning end of the pool. Electronic equipment may be used, including under water display.
- 2.6.7** Each inspector at the starting end shall give a warning signal when the swimmer in their lane has two lengths plus five (5) metres to swim to finish in individual events of 800 and 1500 metres. The signal may be repeated after the turn until the swimmer has reached the five (5) metres mark on the lane rope. The warning signal may be by whistle or bell.
- 2.6.8** Each inspector at the starting end shall determine, in relay events, whether the starting swimmer is in contact with the starting platform when the preceding swimmer touches the starting wall. When Automatic Equipment which judges relay take-offs is available, it shall be used in accordance with Part Two, Article 13.1.
- 2.6.9** Inspectors of Turns shall report to the Referee any violation observed within their jurisdiction.
- 2.7** **Judges of Stroke**
- 2.7.1** Judges of Stroke shall be located on each side of the pool.
- 2.7.2** Each Judge of Stroke shall ensure that the rules related to the style of swimming designated for the event are being observed and shall observe the turns and the finishes to assist the Inspectors of Turns.
- 2.7.3** Judges of Stroke shall report to the Referee any violation observed within their jurisdiction.
- 2.8** **Chief Timekeeper**
- 2.8.1** The Chief Timekeeper shall assign the seating positions for all timekeepers and the lanes for which they are responsible. It is advisable that there shall be three (3) timekeepers for each lane. If Automatic Officiating Equipment is not used there shall be two (2) additional timekeepers designated, either of whom shall be directed to replace a timekeeper whose watch did not start or stopped during an event, or who for any other reason is not able to record the time. When using digital watches, final time and place is determined by time.
- 2.8.2** When only one (1) timekeeper per lane is available, an extra timekeeper must be assigned in case of a malfunction of a watch. In addition, the chief timekeeper must always record the time of the winner of each race.
- 2.8.3** The Chief Timekeeper shall collect from the timekeepers in each lane a card showing the times recorded and, if necessary, inspect their watches.
- 2.8.4** The Chief Timekeeper shall record or examine the official time on the card for each lane.
- 2.9** **Timekeepers**
- 2.9.1** Each timekeeper shall take the time of the swimmers in the lane assigned to him in accordance with Part Two, Article 11.3.
- 2.9.2** Each timekeeper shall start their watch at the starting signal and shall stop it when the swimmer in their lane has completed the race. Timekeepers may be instructed by the Chief Timekeeper to record times at intermediate distances in races longer than 100 metres.
- 2.9.3** Promptly after the race, the timekeepers in each lane shall record the times of their watches on the card, give them to the Chief Timekeeper, and if requested present their watches for inspection. Their watches must be cleared at the short whistle of the Referee announcing the following race.
- 2.9.4** Unless video timing is used, it may be necessary to use the full complement of timekeepers even when Automatic Officiating Equipment is used.

**2.10 Finish Judges – if required**

2.10.1 Finish judges shall be positioned in line with the finish where they have at all times a clear view of the course and the finish line.

2.10.2 After each event the finish judges shall decide and report the placing of the swimmers according to the assignments given to them. Finish judges other than push- button operators shall not act as timekeepers in the same event.

2.11 Chief Recorder (other than for Olympic Games and World Aquatics Championships)

2.11.1 The chief recorder is responsible for checking results from computer printouts or from results of times and placing in each event received from the referee. The chief recorder shall witness the referee's signing the results.

2.12 Recorder (other than for Olympic Games and World Aquatics Championships)

2.12.1 The recorders shall control withdrawals after the heats or semi-finals, enter results on official forms, list all new records established, and maintain scores where appropriate.

2.13 Video Review Supervisor

2.13.1 The Video Review Supervisor shall ensure that Video Review Judges are in their respective posts and fulfil their duties during the competition.

2.13.2 The Video Review Supervisor shall review and confirm all rule infractions reported to them by the Video Review Judges.

2.13.3 The Video Review Supervisor shall review and confirm all rule infractions reported to them at the request of the Referee.

2.13.4 The Video Review Supervisor shall report to the Referee any violation confirmed in the video review.

2.14 Video Review Judge

2.14.1 Each Video Review Judge shall ensure that the rules related to the style of swimming designated for the event are being observed and shall observe the turns and the finishes.

2.14.2 Video Review Judge shall report any violation observed to the Video Review Supervisor. If the infraction is confirmed, the video review judge shall complete a disqualification card.

2.15 Officials' Decision Making

2.15.1 Officials shall make their decision autonomously and independently of each other unless otherwise provided in Part Two.

3 SEEDING OF HEATS, SEMI-FINALS AND FINALS

The starting stations for all events in Olympic Games, World Aquatics Championships, Regional Games and other World Aquatics competitions shall be by seeding as follows:

3.1 Heats

3.1.1 The best competitive times of all entrants for the announced qualifying period prior to the entry deadline of the competition shall be submitted on entry forms or on-line, as requested, and listed in order of time by the Management Committee. Swimmers who do not submit official recorded times shall be considered the slowest and shall be placed at the end of the list with a no time. Placement of swimmers with identical times or of more than one swimmer without times shall be determined by draw. Swimmers shall be placed in lanes according to the procedures set forth in Part Two, Article 3.1.2 below. Swimmers shall be placed in trial heats according to submitted times in the following manner.

3.1.1.1 If one heat, it shall be seeded as a final and swum only during the final session.

3.1.1.2 If two heats, the fastest swimmer shall be seeded in the second heat, next fastest in the first heat, next fastest in the second heat, next in the first heat, etc.



- 3.1.1.3** If three heats, except 400m, 800m and 1500m events, the fastest swimmer shall be placed in the third heat, next fastest in the second, next fastest in the first. The fourth fastest swimmer shall be placed in the third heat, the fifth in the second heat, and the sixth fastest in the first heat, the seventh fastest in the third heat, etc.
- 3.1.1.4** If four or more heats, except 400m, 800m and 1500m events, the last three heats of the event shall be seeded in accordance with Part Two, Article 3.1.1.3 above. The heat preceding the last three heats shall consist of the next fastest swimmers; the heat preceding the last four heats shall consist of the next fastest swimmers, etc. Lanes shall be assigned in descending order of submitted times within each heat, in accordance with the pattern outlined in Part Two, Article 3.1.2 below.
- 3.1.1.5** For 400m, 800m and 1500m events, the last two heats of the event shall be seeded in accordance with Part Two, Article 3.1.1.2.
- 3.1.1.6** Exception: When there are two or more heats in an event, there shall be a minimum of three swimmers seeded into any one preliminary heat, but subsequent scratches may reduce the number of swimmers in such heat to less than three.
- 3.1.1.7** When a ten (10) lane pool is available and equal times are established for the 8th place in the heats or semi-finals of events in excess of 200m and, including relay events, lane O will be used. A random draw will be held to determine which competitor is allocated in lane 8 and lane O. In case of three (3) equal times for 8th place, lane 9 and O will be used with a random draw for lane 8, 9 and O. In the event that there are more than three (3) competitors or teams having equal times for 8th place in the heats or semi-finals, a swim-off may be held.
- 3.1.1.8** Where a 10 lane pool is not available provisions outlined in Part Two, Article 3.2.3 will apply.
- 3.1.2** Except for 50 metre events in 50 metre pools, assignment of lanes shall be (number 1 lane being on the right side of the pool (O when using pools with 10 lanes) when facing the course from the starting end) by placing the fastest swimmer or team in the centre lane in pool with an odd number of lanes, or in lane 3 or 4 respectively in pools having 6 or 8 lanes. In pools using 10 lanes, the fastest swimmer shall be placed in lane 4. The swimmer having the next fastest time is to be placed on their left, then alternating the others to right and left in accordance with the submitted times. Swimmers with identical times shall be assigned their lane positions by draw within the aforesaid pattern.
- 3.1.3** When 50 metre events are contested in 50 metre pools, the races may be swum, at the discretion of the Management Committee, either from the regular starting end to the turning end or from the turning end to the starting end, depending upon such factors as existence of adequate Automatic Equipment, starter's position, etc. The Management Committee should advise swimmers of their determination well before the start of the competition. Regardless of which way the race is swum, the swimmers shall be seeded in the same lanes in which they would be seeded if they were both starting and finishing at the starting end.
- 3.2** **Semi-Finals and Finals**
- 3.2.1** In the semi-finals heats shall be assigned as outlined in Part Two, Article 3.1.1.2.
- 3.2.2** Where no preliminary heats are necessary, lanes shall be assigned in accordance with Part Two, Article 3.1.2 above. Where preliminary heats or semi-finals have been held, lanes shall be assigned as in Part Two, Article 3.1.2 based, however, on times established in such heats.
- 3.2.3** In the event that swimmers from the same or different heats have equal times registered to 1/100 second for either the eighth/tenth place or sixteenth/twentieth place depending on the use of 8 or 10 lanes, there may be a swim-off to determine which swimmer shall advance to the appropriate finals. Such swim-off shall take place after all involved swimmers have completed their heats at a time agreed between the event management and the parties involved. Another swim-off may take place if equal times are registered again. If required, a swim off will take place to determine 1st and 2nd reserve if equal times are recorded.
- 3.2.4** Where one or more swimmers scratch from a semi-final or final reserves will be called in order of classifications in heats or semi-finals. Whenever possible, the event or events must be re-seeded and supplementary sheets must be issued detailing the changes or substitutions, as prescribed in Part Two, Article 3.1.2.
- 3.2.5** For heats, semi-finals and finals, swimmers shall report to the First Call Room at a time determined by the event management. After inspection, swimmers proceed to the final call-room.
- 3.3** In other competitions, the draw system may be used for assigning lane positions.



- 3.4** In the World Aquatics Swimming Championships (25m) and World Aquatics Junior Swimming Championships, the 800m Freestyle and the 1500m Freestyle may at the discretion of the Bureau be conducted on a timed final basis with the fastest heat only conducted during the finals session.

In distances of 50m, 100m and 200m, heats, semi-finals and finals will be held. At the World Aquatics Swimming Championships (25m) and World Aquatics Junior Swimming Championships events of 200m and above only heats and finals will take place.

4 THE START

- 4.1** The start in Freestyle, Breaststroke, Butterfly and Individual Medley races shall be with a dive. On the long whistle (Part Two, Article 2.1.5) from the referee the swimmers shall step onto the starting platform and remain there. On the starter's command "take your marks", they shall immediately take up a starting position with at least one foot at the front of the starting platforms. The position of the hands is not relevant. When all swimmers are stationary, the Starter shall give the starting signal.
- 4.2** The start in Backstroke and Medley Relay races shall be from the water. At the referee's first long whistle (Part Two, Article 2.1.5), the swimmers shall immediately enter the water. At the referee's second long whistle the swimmers shall return without undue delay to the starting position (Part Two, Article 6.1). When all swimmers have assumed their starting positions, the starter shall give the command "take your marks". When all swimmers are stationary, the starter shall give the starting signal.
- 4.3** In Olympic Games, World Aquatics Championships and other World Aquatics events the command "Take your marks" shall be in English and the start shall be by multiple loudspeakers, mounted one at each starting platform.
- 4.4** Any swimmer initiating a start before the signal may be disqualified. If the starting signal sounds before the disqualification is declared, the race shall continue and the swimmer or swimmers shall be disqualified upon completion of the race. If the disqualification is declared before the starting signal, the signal shall not be given, but the remaining swimmers shall be called back and start again. The referee repeats the starting procedure beginning with the long whistle (the second one for Backstroke) as per Part Two, Article 2.1.5.

5 FREESTYLE

- 5.1** Freestyle means that in an event so designated the swimmer may swim any style, except that in individual medley or medley relay events, freestyle means any style other than backstroke, breaststroke or butterfly.
- 5.2** Some part of the swimmer must touch the wall upon completion of each length and at the finish.
- 5.3** Some part of the swimmer must break the surface of the water throughout the race, except it shall be permissible for the swimmer to be completely submerged during the turn and for a distance of not more than 15 metres after the start and each turn. By that point, the head must have broken the surface.

6 BACKSTROKE

- 6.1** Prior to the starting signal, the swimmers shall line up in the water facing the starting end, with both hands holding the starting grips. Standing in or on the gutter or bending the toes over the lip of the gutter is prohibited. When using a backstroke ledge at the start, at least one toe of each foot must be in contact with the end wall or face of the touchpad. Bending the toes over the top of the touchpad is prohibited.
- 6.2** At the signal for starting and after turning the swimmer shall push off and swim upon their back throughout the race except when executing a turn as set forth in Part Two, Article 6.4. The normal position on the back can include a roll movement of the body up to, but not including 90 degrees from horizontal. The position of the head is not relevant.
- 6.3** Some part of the swimmer must break the surface of the water throughout the race, except that once some part of the head of the swimmer has passed the 5 metres mark immediately prior to reaching for the finish, the swimmer may be completely submerged. It is also permissible for the swimmer to be completely submerged during the turn, and for a distance of not more than 15 metres after the start and each turn. By that point the head must have broken the surface.



6.4 When executing the turn there must be a touch of the wall with some part of the swimmer's body. During the turn the shoulders may be turned over the vertical to the breast after which an immediate continuous single arm pull or immediate continuous simultaneous double arm pull may be used to initiate the turn. The swimmer must have returned to the position on the back upon leaving the wall.

6.5 Upon the finish of the race the swimmer must touch the wall while on the back.

7 BREASTSTROKE

7.1 After the start and after each turn, the swimmer may take one arm stroke completely back to the legs during which the swimmer may be submerged. At any time prior to the first Breaststroke kick after the start and after each turn a single butterfly kick is permitted. The head must break the surface of the water before the hands turn inward at the widest part of the second stroke.

7.2 From the beginning of the first arm stroke after the start and after each turn, the body shall be on the breast. It is not permitted to roll onto the back at any time except at the turn after the touch of the wall where it is permissible to turn in any manner as long as the body is on the breast when leaving the wall. From the start and throughout the race the stroke cycle must be one arm stroke and one leg kick in that order. All movements of the arms shall be simultaneous without alternating movement.

7.3 The hands shall be pushed forward together from the breast on, under, or over the water. The elbows shall be under water except for the final stroke before the turn, during the turn and for the final stroke at the finish. The hands shall be brought back on or under the surface of the water. The hands shall not be brought back beyond the hip line, except during the first stroke after the start and each turn.

7.4 During each complete cycle, some part of the swimmer's head must break the surface of the water. All movements of the legs shall be simultaneous without alternating movement.

7.5 The feet must be turned outwards during the propulsive part of the kick. Alternating movements or downward butterfly kicks are not permitted except as in Part Two, Article 7.1. Breaking the surface of the water with the feet is allowed unless followed by a downward butterfly kick.

7.6 At each turn and at the finish of the race, the touch shall be made with both hands separated* and simultaneously at, above, or below the water level. At the last stroke before the turn and at the finish an arm stroke not followed by a leg kick is permitted. The head may be submerged after the last arm pull prior to the touch, provided it breaks the surface of the water at some point during the last complete or incomplete cycle preceding the touch.

*"Separated" means that the hands cannot be stacked one on top of the other. It is not necessary to see space between the hands. Incidental contact at the fingers is not a concern.

8 BUTTERFLY

8.1 From the beginning of the first arm stroke after the start and each turn, the body shall be kept on the breast. It is not permitted to roll onto the back at any time, except at the turn after the touch of the wall where it is permissible to turn in any manner as long as the body is on the breast when leaving the wall.

8.2 Both arms shall be brought forward simultaneously over the water and brought backward simultaneously under the water through-out the race, subject to Part Two, Article 8.5.

8.3 All up and down movements of the legs must be simultaneous. The legs or the feet need not be on the same level, but they shall not alternate in relation to each other. A breaststroke kicking movement is not permitted.

8.4 At each turn and at the finish of the race, the touch shall be made with both hands separated and simultaneously, at, above or below the water surface.

8.5 At the start and at turns, a swimmer is permitted one or more leg kicks and one arm pull under the water, which must bring him to the surface. It shall be permissible for a swimmer to be completely submerged for a distance of not more than 15 metres after the start and after each turn. By that point, the head must have broken the surface. The swimmer must remain on the surface until the next turn or finish.



9 MEDLEY SWIMMING

- 9.1** In individual medley events, the swimmer covers the four swimming strokes in the following order: Butterfly, Backstroke, Breaststroke and Freestyle. Each of the strokes must cover one quarter (1/4) of the distance.
- 9.2** In Freestyle the swimmer must be on the breast except when executing a turn. The swimmer must return to the breast before any kick or stroke. Leaving the wall on the back during the freestyle portion is permissible but no kicking action is permitted until the swimmer has returned past the vertical to the breast at which point kicking, including a butterfly kick(s), may commence.
- 9.3** In Medley relay events, swimmers will cover the four swimming strokes in the following order: Backstroke, Breaststroke, Butterfly and Freestyle. Each of the strokes must cover one quarter (1/4) of the distance.
- 9.4** Each section must be finished in accordance with the rule which applies to the stroke concerned.

10 THE RACE

- 10.1** All individual races must be held as separate gender events.
- 10.2** A swimmer swimming over the course alone shall cover the whole distance to qualify. A swimmer who does not complete the whole distance in accordance with the relevant World Aquatics rules shall be disqualified.
- 10.3** On the pool deck, after respecting the presentation protocol outlined in Part Two, Article 1.5, the competitors must immediately remove all clothing except for swimwear.
- 10.4** The swimmer must remain and finish the race in the same lane in which he/she started.
- 10.5** In all events, a swimmer when turning shall make physical contact with the end of the pool or course. The turn must be made from the wall, and it is not permitted to take a stride or step from the bottom of the pool.
- 10.6** Standing on the bottom during freestyle events or during the freestyle portion of medley events shall not disqualify a swimmer, but shall not walk.
- 10.7** Pulling on the lane rope is not allowed.
- 10.8** Obstructing another swimmer by swimming across another lane or otherwise interfering shall disqualify the offender. Should the foul be intentional, the referee shall report the matter to the Member promoting the race, and to the Member of the swimmer so offending.
- 10.9** Any swimmer not entered in a race, who enters the water in which an event is being conducted before all swimmers therein have completed the race, shall be disqualified from their next scheduled race in the meet.
- 10.10** There shall be four swimmers on each relay team. Mixed relays may be swum. Mixed Relays must consist of two (2) Men and two (2) Women. Split times achieved in these events cannot be used for records and/or entry purposes.
- 10.11** Relay exchanges must commence from the starting platform. Running starts from the pool deck are not permitted.
- 10.12** In relay events, the team of a swimmer whose feet lose touch with the starting platform before the preceding team-mate touches the wall shall be disqualified.
- 10.13** Any relay team shall be disqualified from a race if a team member, other than the swimmer designated to swim that length, enters the water when the race is being conducted, before all swimmers of all teams have finished the race.
- 10.14** The members of a relay team and their order of competing must be nominated before the race. Any relay team member may compete in a race only once. The composition of a relay team may be changed between the heats and finals of an event, provided that it is made up from the list of swimmers properly entered by a member for that event. Failure to swim in the order listed will result in disqualification. Substitutions may be made only in the case of a documented medical emergency.
- 10.15** Any swimmer having finished their race, or their distance in a relay event, must leave the pool as soon as possible without obstructing any other swimmer who has not yet finished their race. Otherwise, the swimmer committing the fault, or their relay team, shall be disqualified.



- 10.16** Should a foul endanger the chance of success of a swimmer, the referee shall have the power to allow him to compete in the next heat or, should the foul occur in a final event or in the last heat, he/she may order it to be re-swum.
- 10.17** No pace-making shall be permitted, nor may any device be used or plan adopted which has that effect.

11 TIMING

- 11.1** The operation of Automatic Officiating Equipment shall be under the supervision of appointed officials. Times recorded by Automatic Equipment shall be used to determine the winner, all placing and the time applicable to each lane. The placing and times so determined shall have precedence over the decisions of timekeepers. In the event that a break-down of the Automatic Equipment occurs or that it is clearly indicated that there has been a failure of the Equipment, or that a swimmer has failed to activate the Equipment, the recordings of the timekeepers shall be official (See Part Two, Article 13.3). In the event that there is failure of all timing devices in a lane then the swimmer may be offered a reswim.
- 11.2** When Automatic Officiating Equipment is used, the results shall be recorded only to 1/100 of a second. In the event of equal times, all swimmers who have recorded the same time at 1/100 of a second shall be accorded the same placing. Times displayed on the electronic scoreboard should show 1/100 of a second.
- 11.3** Any timing device that is terminated by an official shall be considered a watch. Such manual times must be taken by three timekeepers appointed or approved by the Member in the country concerned. All watches shall be certified as accurate to the satisfaction of the governing body concerned. Manual timing shall be registered to 1/100 of a second. Where no Automatic Equipment is used, official manual times shall be determined as follows:
- 11.4** If two (2) of the three (3) watches record the same time and the third disagrees, the two identical times shall be the official time.
- 11.5** If all three (3) watches disagree, the watch recording the intermediate time shall be the official time.
- 11.6** With only two (2) out of three (3) watches working the average time shall be the official time. When this calculation results in a value that is expressed in thousandths of a second, the final digit shall be dropped without rounding.
- 11.7** Should a swimmer be disqualified during or following an event, such disqualification should be recorded in the official results, but no time or place shall be recorded or announced.
- 11.8** In the case of a relay disqualification, legal splits up to the time of the disqualification shall be recorded in the official results.
- 11.9** All 50 metre and 100 metre splits shall be recorded for lead-off swimmers during relays and published in the official results.

12 WORLD RECORDS

- 12.1** For World Records and World Junior Records in **50 metre courses**, the following distances and styles for both sexes shall be recognised:

Freestyle	50, 100, 200, 400, 800 and 1500 metres
Backstroke	50, 100 and 200 metres
Breaststroke	50, 100 and 200 metres
Butterfly	50, 100 and 200 metres
Individual Medley	200 and 400 metres
Freestyle Relays	4x100 and 4x200 metres
Medley Relay	4x100 metres
Mixed Relays	4x100 metres Freestyle and 4x100 metres Medley

- 12.2** For World Records and World Junior Records in **25 metre courses**, the following distances and styles for both sexes shall be recognised:



Freestyle	50, 100, 200, 400, 800 and 1500 metres
Backstroke	50, 100 and 200 metres
Breaststroke	50, 100 and 200 metres
Butterfly	50, 100 and 200 metres
Individual Medley	100, 200 and 400 metres
Freestyle Relays	4x50, 4x100 and 4x200 metres
Medley Relay	4x50 and 4x100 metres
Mixed Relays	4x50 metres Freestyle and 4x50 metres Medley

- 12.3** The age groups for World Junior Records are the same as for the World Aquatics Junior Swimming Championships.
- 12.4** Members of relay teams must be of the same nationality.
- 12.5** All records must be made in scratch competition or an individual race against time, held in public and announced publicly by advertisement at least three days before the attempt is to be made. In the event of an individual race against time being sanctioned by a Member Federation, as a time trial during a competition, then an advertisement at least three (3) days before the attempt is to be made shall not be necessary.
- 12.6** The length of each lane of the course must be certified by a surveyor or other qualified official appointed or approved by the Member Federation in the country in which it is situated.
- 12.7** Where a moveable bulkhead is used, course measurement of the lane must be confirmed at the conclusion of the session during which the time was achieved.
- 12.8** World Records and World Junior Records will be accepted only when times are recorded by Automatic Officiating Equipment, or Semi-Automatic Officiating Equipment in the case of Automatic Officiating Equipment system malfunction.
- 12.9** World Records and World Junior Records can be established only by swimmers wearing World Aquatics approved swimwear (see Part Two, Article 15).
- 12.10** Times which are equal to 1/100 of a second will be recognised as equal records and swimmers achieving these equal times will be called «Joint Holders». Only the time of the winner of a race may be submitted for a World Record – except for World Juniors Records. In the event of a tie in a record-setting race, each swimmer who tied shall be considered a winner.
- 12.11** Worlds Records and World Junior Records can be established only in water with less than 3 gr/litre of salt. No World Records will be recognized in any kind of sea or ocean water.
- 12.12** The first swimmer in a relay, except in mixed relays, may apply for a World Record or a World Junior Record. Should the first swimmer in a relay team complete his/her distance in record time in accordance with the provisions of this subsection, his/her performance shall not be nullified by any subsequent disqualification of his/her relay team for violations occurring after his/her distance has been completed.
- 12.13** A swimmer in an individual event may apply for a World Record or a World Junior Records at an intermediate distance if he/she or his/her coach or manager specifically requests the referee that their performance be especially timed or if the time at the intermediate distance is recorded by Automatic Officiating Equipment. Such swimmer must complete the scheduled distance of the event to apply for a record at the intermediate distance.
- 12.14** Applications for World Records and World Junior Records must be made on the World Aquatics official form by the responsible authority of the organizing or management committee of the competition and signed by an authorized representative of the Member Federation in the country of the swimmer, certifying that all regulations have been observed including certification of the pool measurement and that the athlete was subject to an anti-doping test immediately after the race, or at the latest, within 24 hours of the conclusion of the Event, and such test returned a negative finding. When a relay team breaks or equals a World Record / World Junior Record, only the four Athletes who swam this specific race must return a negative finding. The application form shall be forwarded to the Executive Director of World Aquatics within fourteen (14) days after the performance.
- 12.15** A claim of a World Record or a World Junior Record performance shall be provisionally reported by e-mail to the Executive Director of World Aquatics within seven (7) days of the performance.



- 12.16** The Member Federation in the country of the swimmer should report this performance by letter to the Executive Director of World Aquatics for information and action, if necessary, to assure that the official application has been properly submitted by the appropriate authority.
- 12.17** On receipt of the official application, and upon satisfaction that the information contained in the application, including a certification of the pool measurement and a negative doping control test certificate, is accurate, the Executive Director of World Aquatics shall declare the new World Record or World Junior Record, see that such information is published, and see that certificates are provided to those persons whose applications have been accepted.
- 12.18** All records made during the Olympic Games, World Aquatics Championships, World Aquatics Junior Swimming Championships and Swimming World Cups shall be automatically approved.
- 12.19** If the procedure of Part Two, Article 12.14 has not been followed, the Member Federation in the country of a swimmer can apply for a World Record or a World Junior Record in default thereof. After due investigation, the Executive Director of World Aquatics is authorised to accept such record if the claim is found to be correct.
- 12.20** If the application for a World Record or a World Junior Record is accepted by World Aquatics, a diploma, signed by the President of World Aquatics shall be forwarded by the Executive Director to the Member Federation in the country of the swimmer for presentation to the swimmer in recognition of the performance. A fifth World Record diploma will be issued to all Member Federations whose relay teams establish a World Record or a World Junior Record. This diploma is to be retained by the Member Federation.
- 12.21** From time to time, World Aquatics may add new events for which swimmers may establish World Records or World Junior Records. For each such event, World Aquatics will establish Target Times; if a swimmer achieves a time that is better than the Target Time, it shall be considered a World Record or World Junior Record, as long as all requirements in Part Two, Article 12 are met.

13 AUTOMATIC OFFICIATING PROCEDURE

- 13.1** When Automatic Officiating Equipment (See Part Two, Article 16.3 - Automatic Officiating Equipment for Swimming) is used in any competition, the placing and times so determined and relay take-offs judged by such equipment shall have precedence over the timekeepers and Inspectors of Turns.
- 13.2** When the Automatic Officiating Equipment fails to record the place and/or time of one or more swimmers in a given race:
- 13.2.1** Record all available Automatic Officiating Equipment times and places,
- 13.2.2** Record all human times and places.
- 13.2.3** The official place will be determined as follows:
- 13.2.3.1** A swimmer with an Automatic Officiating Equipment time and place must retain their relative order when compared with the other swimmers having an Automatic Officiating Equipment time and place within that race.
- 13.2.3.2** A swimmer not having an Automatic Officiating Equipment place but having an Automatic Officiating Equipment time will establish their relative order by comparing their Automatic Officiating Equipment time with the Automatic Officiating Equipment times of the other swimmers.
- 13.2.3.3** A swimmer having neither an Automatic Officiating Equipment place nor an Automatic Officiating Equipment time shall establish their relative order by the time recorded by the Semi-Automatic Officiating Equipment or by watches.
- 13.3** The official time will be determined as follows:
- 13.3.1** The official time for all swimmers having an Automatic Officiating Equipment time will be that time.
- 13.3.2** The official time for all swimmers not having an Automatic Officiating Equipment time will be the times recorded by Semi-Automatic Officiating Equipment or watches.
- 13.4** To determine the relative order of finish for the combined heats of an event, proceed as follows:
- 13.4.1** The relative order of all swimmers will be established by comparing their official times.



- 13.4.2** If a swimmer has an official time which is tied with the official time(s) of one or more swimmers, all swimmers having that time shall be tied in their relative order of finish in that event.

14 AGE GROUP RULES – SWIMMING

14.1 World Aquatics Junior Swimming Championships

Age groups shall be between 14-18 years, as of 31st December in the year of competition, for both Boys and Girls.

- 14.2** Minimum age for Olympic Games, World Aquatics Championships and World Aquatics Swimming Championships (25m).

The minimum age for swimmers competing in the Olympic Games, World Aquatics Championships and World Aquatics Swimming Championships (25m) shall be the same as the minimum age for the World Aquatics Junior Swimming Championships: Girls and Boys, at least 14 years of age, on 31st December in the year of competition. Younger competitors may participate in these competitions if they have achieved at least the “B” Standard Entry Time in the respective event.

- 14.3** Federations may adopt their own Age Group rules, using World Aquatics Competition Regulations.

15 SWIMWEAR AND WEARABLES

- 15.1** Competitors must wear only one swimsuit in one or two pieces. No additional items, like arm bands or leg bands shall be regarded as parts of a swimsuit. All swimsuits shall comply with the requirements set forth in these Competition Regulations.

- 15.2** For swimming competitions, swimsuits for men shall not extend above the navel nor below the knee. For women, the swimsuit shall not cover the neck, nor extend past the shoulder, nor below knee. The swimsuits shall be made from textile materials.

- 15.3** No swimmer shall be permitted to use or wear any device or swimsuit that may aid his/her speed, buoyancy or endurance during a competition (such as webbed gloves, flippers, fins, power bands, or adhesive substances, etc.). The use of technology and automated data collection devices is permissible for the sole purpose of collecting data. Automated devices shall not be utilised to transmit data, sounds, or signals to the swimmer and may not be used to aid their speed. Goggles may be worn. As a consequence of injury, it is permissible to tape not more than one or two fingers or toes. Any other kind of tape on the body is not permitted unless approved by the Referee or other designated person.

- 15.4** A World Record (including Junior World Record and Masters World Record) will only be recognised by World Aquatics if approved swimwear has been used.

World Aquatics may request the Athlete to submit her/his swimsuit worn during the World Record for conducting further analysis in its laboratory.

16 SWIMMING FACILITIES AND EQUIPMENT

16.1 Swimming Facilities

16.1.1 Length

16.1.1.1 50.000 metres

When touch panels of Automatic Officiating Equipment are used on the starting end, or additionally on the turning end, the pool must be of such length that ensures the required distance of 50.000 metres between the two panels.

16.1.1.2 25.000 metres

When touch panels of Automatic Officiating Equipment are used on the starting end, or additionally on the turning end, the pool must be of such length that ensures the required distance of 25.000 metres between the two panels.

16.1.2 Dimensional Tolerances
16.1.2.1 50m swimming pools

The admissible tolerance in 50.000 m swimming pools will be: +0.010, and -0.000 metre when touch panels are installed.

Tolerances will be measured as follows:

For swimming pools with touch panels of Automatic Officiating Equipment on both ends the Wall to Wall distance shall be:

Minimum 50.020 metre / Maximum 50.030 metre.

Tolerances have to be consistent 0.300 metre above to 0.800 metre below the water surface.

These measurements should be certified by a surveyor or other qualified official, appointed or approved by the Member in the country in which the pool is situated.

16.1.2.2 25m swimming pools

The admissible tolerance in 25.000 m swimming pools will be +0.010, and -0.000 metre when touch panels are installed.

Tolerances will be measured as follows:

For swimming pools with touch panels of Automatic Officiating Equipment on both ends the Wall to Wall distance shall be:

Minimum	Maximum
25.020 metre	25.030 metre

For swimming pools with a touch panel of Automatic Officiating Equipment on one end the Wall to Wall distance shall be:

Minimum	Maximum
25.010 metre	25.020 metre

Tolerances have to be consistent 0.300 metre above to 0.800 metre below the water surface.

These measurements should be certified by a surveyor or other qualified official, appointed or approved by the Member in the country in which the pool is situated.

16.1.3 Width

There is no minimum width requirement. However, the width of the pool has to comply with the provision in Part Two, Article 16.1.6 – Lanes.

16.1.4 Depth

A minimum depth of 1.35 metres, extending from 1.0 metre to at least 6.0 metres from the end wall is required for pools with starting blocks. A minimum depth of 1.0 metre is required elsewhere.

16.1.5 Walls

16.1.5.1 End walls shall be vertical, parallel and form 90-degree right angles to the swimming course and to the surface of the water. They shall be constructed of solid material, with a slip-resistant surface extending 0.8 metre below the water surface, so as to enable the competitor to touch and push off in turning without hazard. The admissible tolerance in walls verticality will be ± 0.3 degrees.

16.1.5.2 Rest ledges along the pool walls are permitted; they must be not less than 1.2 metres below the water surface, and may be 0.1 metre to 0.15 metre wide. Both internal and external ledges are acceptable, however internal ledges are preferred.

16.1.5.3 Gutters may be placed on all four walls of the pool. If end wall gutters are installed, they must allow for attachment of touch panels to the required 0.3 metre above the water surface. They must be covered with a suitable grill or screen.

**16.1.6 Lanes**

There is no minimum number of lanes. Lanes shall be at least 2.5 metres wide, first and last lane may be 2.4 metres wide with 2 spaces of at least 0.1 metres wide outside of the first and the last lanes.

16.1.7 Lane Ropes**16.1.7.1** The main function of a lane rope is not only to separate swimming lanes, but to reduce the pool waves. A lane rope should have the properties to reduce the waves going through to the other side of rope or bouncing back into the swimming lane.

Lane ropes shall extend the full length of the course and components not contributing to its wave reduction function, such as tension spring and take-up reel, shall measure less than 200mm each end of rope.

Lane rope should be secured at each end wall to anchor brackets recessed into the end walls. If anchor placement is on pool deck, an extender, firm and non-elastic, should be in place. The installed lane rope should stay in the pool water. The anchor, including extender, shall not extend more than 10mm into the pool. The anchor shall not influence the length of the lane rope by more than ± 10 mm each end of rope.

The anchor shall be positioned so that the wave reducing components at each end wall of the pool shall be 50% below the surface of the water. Anchors should be installed to withstand 20kN. Each lane rope will consist of wave reducing components placed end-to-end having a minimum diameter of 0.10 metre. The design of discs and floats should be so that the floats, by themselves, do not influence the length of the lane rope. A float should be an integral part in between two discs. The lane rope length of the course shall have a negative buoyancy in such a way that at least one half to maximum two thirds of the height of the wave reducing components should be beneath the water surface.

The take-up reel of the lane rope should require a tool to lock tensioning into position and to prevent non-authorized tampering. The lane rope shall be equipped with a tension spring, absorbing sudden high point loads and a wire withstanding a tensile force of 12kN.

In an eight (8) lane pool, lane ropes shall extend the full length of the course, secured at each end wall to anchor brackets recessed into the end walls. The anchor shall be positioned so that the floats at each end wall of the pool shall be on the surface of the water. Each lane rope will consist of floats placed end-to-end having a minimum diameter of 0.10 metre to a maximum of 0.15 metre.

In a swimming pool the colour of the lane ropes should be as follows, although variations in the colour scheme can be used:

- Two (2) GREEN ropes for lanes 1 and 8
- Four (4) BLUE ropes for lanes 2, 3, 6 and 7
- Three (3) YELLOW ropes for lanes 4 and 5

The floats extending for a distance of 5.0 metres from each end of the pool shall be of RED colour.

There shall not be more than one lane rope between each lane. The lane ropes shall be firmly stretched and the tensions should be 1-1,2kN.

See Swimming Diagrams, Part Two, Annex 1, 6, and 7

16.1.7.2 At the 15-metre mark from each end wall of the pool the components shall be distinct in colour from the surrounding components.**16.1.7.3** In 50 metre pools the components shall be distinct to mark 25 metres.**16.1.7.4** Lane numbers of soft material may be placed on the lane ropes at the start and turning end of the pool.**16.1.8 Starting Platforms**

Starting Platforms shall be firm and give no springing effect. The height of the platform above the water surface shall be from 0.5 metre to 0.75 metre. The surface area shall be at least 0.5 metre x 0.5 metre and covered with a slip-resistant material.



Maximum slope shall not be more than 10 degrees. The starting platform may have an adjustable setting back plate. The platform shall be constructed so as to permit the gripping of the platform by the swimmer in the forward start at the front and the sides; it is recommended that, if the thickness of the starting platform exceeds 0.04 metre, grips of at least 0.1 metre width on each side and 0.4 metre width in the front be cut out to 0.03 metre from the surface of the platform.

Handgrips for the forward start may be installed on the sides of the starting platforms. Handgrips for backstroke starts shall be placed within 0.3 metre to 0.6 metre above the water surface both horizontally and vertically. They shall be parallel to the surface of the end wall and must not protrude beyond the end wall.

A minimum depth of 1.35 metres, extending from 1.0 metre to at least 6.0 metres from the end wall is required for pools with starting blocks. Electronic read-out boards may be installed under the blocks. Flashing is not allowed. Figures must not move during a backstroke start.

16.1.9 Numbering

Each starting block must be distinctly numbered on all four sides, clearly visible. It is recommended that lane number 0 shall be on the right-hand side when facing the course from the starting end with exception of 50m events, which may start from the opposite end. Touch panels may be numbered on the top part.

16.1.10 Backstroke Turn Indicators

Flagged ropes shall be suspended across the pool, 1.8 metres above the water surface, from fixed standards placed 5.0 metres from each end wall. Distinctive marks must be placed on both sides of the pool, and where possible on each lane rope, 15.0 metres from each end wall.

Flags must be fixed to the ropes having the following dimensions: 0.20 metres on the rope forming a triangle measuring 0.40 metres on the sides. The distance between each flag must be 0.25 metres. If the flags are printed with or support / carry any signage this must be approved in advance by World Aquatics.

16.1.11 Backstroke Ledge

Backstroke ledges conforming to the specification set out below shall be used in all World Aquatics Championships and Competitions.

The ledge: (see diagram below)

- shall be adjustable to 4 cm above or 4 cm below the water level and may not be used outside of this range;
- is a minimum of 65 cm in length;
- must be 8 cm in height, 2 cm at the width with 10 degrees of slope.

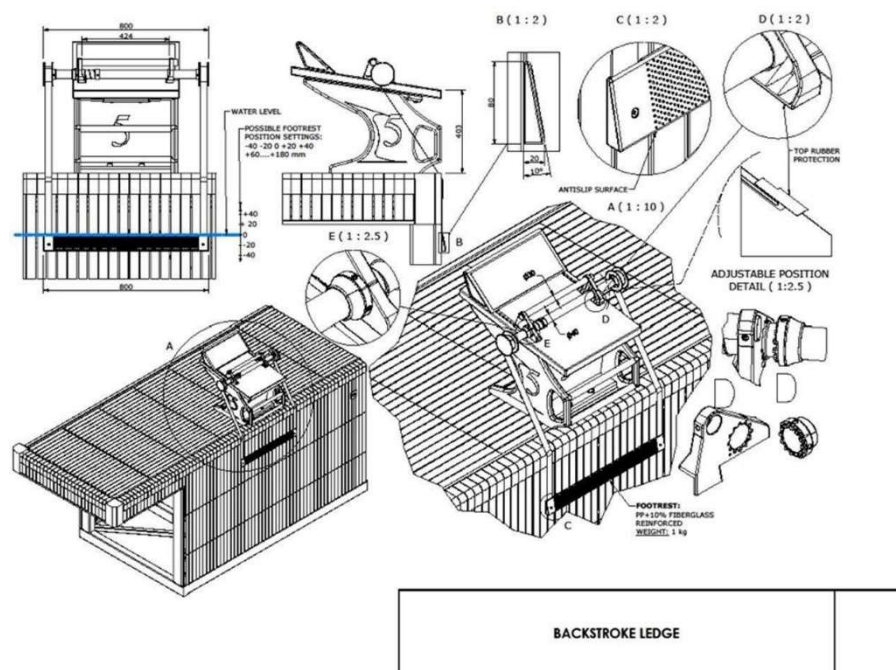

**16.1.12 False Start Rope**

False Start Rope may be suspended across the pool not less than 1.2 metres above the water level from fixed standards placed 15.0 metres in front of the starting end. It shall be attached to the standards by a quick release mechanism. The rope must effectively cover all lanes when activated.

16.1.13 Water conditions**16.1.13.1 Water Temperature**

Water temperature shall be 25° to 28°C.

16.1.13.2 Movement

During competition, the water in the pool must be at a constant level, with no appreciable movement.

In order to keep the water level, preserve the transparency of water and take into consideration the health regulations in force in most countries, inflow and outflow has to be regulated as follows:

- 220 to 250 m³/h for 50.00 m pools
- 150 to 180 m³/h for 33.33 m pools
- 120 to 150 m³/h for 25.00 m pools

In daily use, inflow and outflow has to follow the health regulation of each country.

At these turnover rates, the water distribution has to be such that no appreciable current or turbulence is created.

“Appreciable current” is defined as water movement that can move a floating basketball (filled with 6 litres of water to obtain the right buoyancy) in one direction for more than 1,25m in 60 seconds.

The practical way to test this is to install two floating lines crosswise in a swim lane (to obtain a square with 2,5m size, ref. Image 1) and then to leave the basketball in the central point of the square. If the ball does not touch any of the four lane ropes within 60 seconds, the turbulence test is successful.

Test should be repeated in lanes 1,3,6,8 on two sides, at 5m from each end of the pool (end wall or bulkhead).

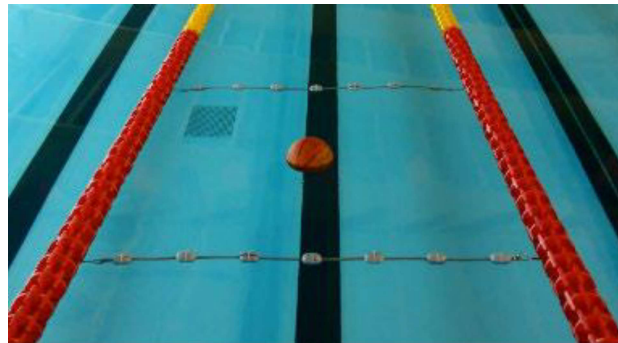
**16.1.13.3 Salinity of the water**

World Records and World Junior Records can be established only in water with less than 3 gr/litre of salt.

No World Records will be recognized in any kind of sea or ocean water.

16.1.14 Lighting

Light intensity over starting platforms and turning ends shall not be less than 600 lux.

16.1.15 Lane Markings

Lane Markings shall be of a dark contrasting colour, placed on the floor of the pool in the centre of each lane.



Width:	minimum 0.2 metre, maximum 0.3 metre.
Length:	46.0 metres for 50 metre long pools; 21.0 metres for 25 metre long pools.

Each lane line shall end 2.0* metres from the end wall of the pool with a distinctive cross line 1.0 metre long and of the same width as the lane line. The distance between the centre points of each lane shall be 2.5 metres.

*Pool length tolerances must be considered.

Target lines shall be placed on the end walls or on the touch panels, in the centre of each lane, of the same width as the lane lines.

They shall extend without interruption from the deck edge (curb), to the floor of the pool to a maximum of 3 metres. A cross line 0.5 metre long shall be placed 0.3 metre below the water surface, measured to the centre point of the cross line.

For 50m and 25m pools constructed after 1st January 2006, cross lines 0.5 metre long shall be placed at the 15 metre mark from each end of the pool. After October 2013 this shall be measured from the end wall to the centre point of the cross line.

16.1.16 Bulkheads

When a bulkhead serves as an end wall, it must extend the full width of the course and present a solid smooth, non-slippery stable vertical surface on which touch pads may be mounted extending not less than 0.8m below and 0.3m above the surface of the water, and must be free of hazardous openings above or below the waterline which may be penetrated by a swimmer's hands, feet, toes or fingers. A bulkhead must be of a design that provides for the free movement of officials along its length without such movement creating any appreciable current or water turbulence.

16.2 Swimming Facilities for Olympic Games and World Aquatics Championships

16.2.1 Length

50.0 metres between the Automatic Officiating Equipment touch panels, except for the World Aquatics Swimming Championships (25m), which shall be 25.0 metres between the Automatic Officiating Equipment touch panels at the starting end and the wall or touch panels at the turning end.

16.2.2 Dimensional Tolerances

16.2.2.1 50m swimming pools

The admissible tolerance in 50.00 m swimming pools will be +0.010, and -0.000 metre when touch panels are installed.

Tolerances will be measured as follows:

For swimming pools with touch panels of Automatic Officiating Equipment on both ends the Wall-to-Wall distance shall be: Minimum 50.020 metre / Maximum 50.030 metre.

Tolerances have to be consistent 0.300 metre above to 0.800 metre below the water surface.

These measurements should be certified by a surveyor or other qualified official, appointed or approved by the Member in the country in which the pool is situated.

See Swimming Diagrams in Part Two, Annex 1, 2, 3, and 4

16.2.2.2 25m swimming pools

The admissible tolerance in 25.00 m swimming pools will be +0.010, and -0.000 metre when touch panels are installed.

Tolerances will be measured as follows:

For swimming pools with touch panels of Automatic Officiating Equipment on both ends the Wall to Wall distance shall be:

Minimum 25.020 metre / Maximum 25.030 metre.



For swimming pools with a touch panel of Automatic Officiating Equipment on one end the Wall to Wall distance shall be:

Minimum 25.010 metre / Maximum 25.020 metre.

Tolerances have to be consistent 0.300 metre above to 0.800 metre below the water surface.

These measurements should be certified by a surveyor or other qualified official, appointed or approved by the Member in the country in which the pool is situated.

16.2.3 Width

16.2.3.1 Olympic Games

Permanent Swimming Pools: A minimum of 25.00 metres Temporary Swimming Pools: 26.00 metres.

16.2.3.2 World Aquatics Championships

Permanent Swimming Pools: A minimum of 25.00 metres Temporary Swimming Pools: 26.00 metres.

16.2.4 Depth

16.2.4.1 Olympic Games and World Aquatics Championships (50m)

A minimum of 2.5 metres.

16.2.4.2 World Aquatics Swimming Championships (25m)

A minimum of 2.0 metres, 2.5 metres preferred.

16.2.4.3 When the pool is used for multi-sports (i.e., Artistic Swimming and Swimming) at either the Olympic Games or World Aquatics Championships

A minimum of 3 metres required.

16.2.5 Walls

16.2.5.1 End walls shall be vertical, parallel and form 90-degree right angles to the swimming course and to the surface of the water. They shall be constructed of solid material, with a slip-resistant surface extending 0.8 metre below the water surface, so as to enable the competitor to touch and push off in turning without hazard.

The admissible tolerance in walls verticality will be ± 0.3 degrees.

16.2.5.2 Rest ledges along the pool walls are permitted; they must be not less than 1.2 metres below the water surface, and may be 0.1 metre to 0.15 metre wide. Both internal and external ledges are acceptable, however internal ledges are preferred.

16.2.5.3 Gutters may be placed on all four walls of the pool. If end wall gutters are installed, they must allow for attachment of touch panels to the required 0.3 metre above the water surface. They must be covered with a suitable grill or screen.

16.2.6 Lanes

16.2.6.1 Number of lanes:

Eight (8) lanes for Olympic Games, although 9 or 10 lanes may be used with approval from the Chair of the Technical Swimming Committee when faced with unusual circumstances. [Example: a tie from preliminaries for 8th place in the 1500-metre freestyle].

Ten (10) lanes for World Aquatics Championships.

16.2.6.2 Olympic Games

Lanes shall be 2.5 metres wide with 2 spaces 2.5 metres wide outside of lanes 1 and 8. There must be a lane rope separating these spaces from lanes 1 and 8.

See Swimming Diagram, Part Two, Annex 1

16.2.6.3 World Aquatics Championships



For permanent swimming pools, lanes from 1 to 8 shall be 2.5 metres wide and lanes 0 and 9 shall be 2.4 metres wide with 2 spaces 0.1 metres wide outside of lanes 0 and 9. There must be a lane rope separating these spaces from lanes 0 and 9 for World Championships.

See Diagrams Part Two, Annex 2 and 8

For temporary swimming pools, lanes shall be 2.5 metres wide with 2 spaces 0.5 metres wide outside of lanes 0 and 9. There must be a lane rope separating these spaces from lanes 0 and 9.

See Diagrams, Part Two, Annex 3 and 9

16.2.7 Lane Ropes

16.2.7.1 The main function of a lane rope is not only to separate swimming lanes, but to reduce the pool waves. A lane rope should have the properties to reduce the waves going through to the other side of rope or bouncing back into the swimming lane.

Lane ropes shall extend the full length of the course, secured at each end wall to anchor brackets recessed into the end walls. The anchor shall be positioned so that the floats at each end wall of the pool shall be on the surface of the water. Each lane rope will consist of floats placed end-to-end having a minimum diameter of 0.15 metre.

Lane rope should be secured at each end wall to anchor brackets recessed into the end walls. If anchor placement is on pool deck, an extender, firm and non-elastic, should be in place.

The installed lane rope should stay in the pool water. The anchor, including extender, shall not extend more than 10mm into the pool. The anchor shall not influence the length of the lane rope by more than ± 10 mm each end of rope.

The anchor shall be positioned so that the wave reducing components at each end wall of the pool shall be 50% below the surface of the water. Anchors should be installed to withstand 20kN. Each lane rope will consist of wave reducing components placed end-to-end having a diameter of 0, 15 metre. The design of discs and floats should be so that the floats, by themselves, do not influence the length of the lane rope. A float should be an integral part in between two discs. The lane rope length of the course shall have a negative buoyancy in such a way that at least one half to maximum two thirds of the height of the wave reducing components should be beneath the water surface.

The take-up reel of the lane rope should require a tool to lock tensioning into position and to prevent non-authorized tampering. The lane rope shall be equipped with a tension spring, absorbing sudden high point loads and a wire withstanding a tensile force of 12kN.

The components extending for a distance of 5.0 metres from each end of the pool shall be of RED colour.

There shall not be more than one lane rope between each lane. The lane ropes shall be firmly stretched and the tensions should be 1-1,2kN.

In a swimming pool the colour of the lane ropes should be as follows:

16.2.7.1.1 Olympic Games

In an eight (8) lane swimming pool the colour of the lane ropes should be as follows, although variations in the colour scheme can be used:

- Two (2) GREEN ropes for lanes 1 and 8
- Four (4) BLUE ropes for lanes 2, 3, 6 and 7
- Three (3) YELLOW ropes for lanes 4 and 5



		GREEN	
1		BLUE	
2		BLUE	
3		YELLOW	
4		YELLOW	
5		YELLOW	
6		BLUE	
7		BLUE	
8		GREEN	

16.2.7.1.2 World Aquatic Championships

In a ten (10) lane swimming pool the colour of the lane ropes should be as follows, although variations in the colour scheme can be used:

- Two (2) GREEN ropes for lanes 0 and 9
- Six (6) BLUE ropes for lanes 1, 2, 3, 6, 7 and 8
- Three (3) YELLOW ropes for lanes 4, 5

See Swimming Diagrams, Part Two, Annex 2, 3, 8, and 9

The floats extending for a distance of 5.0 metres from each end of the pool shall be of RED colour.

		GREEN	
0		BLUE	
1		BLUE	
2		BLUE	
3		BLUE	
4		YELLOW	
5		YELLOW	
6		YELLOW	
7		BLUE	
8		BLUE	
9		BLUE	
		GREEN	

16.2.7.2 At the 15-metre mark from each end wall of the pool the components shall be distinct in colour from the surrounding components.

16.2.7.3 In 50 metre pools the components shall be distinct to mark 25 metres.

16.2.7.4 Lane numbers of soft material may be placed on the lane ropes at the start and turning end of the pool.

16.2.7.5 Lane marking measurements, please read in conjunction with pool diagrams.

16.2.8 Starting Platforms

Starting Platforms shall be firm and give no springing effect. The height of the platform above the water surface shall be from 0.5 metre to 0.75 metre. The surface area shall be at least 0.5 metre x 0.6 metre and covered with a slip-resistant material.

Maximum slope shall not be more than 10 degrees. The starting platform may have an adjustable setting back plate. The platform shall be constructed so as to permit the gripping of the platform by the swimmer in the forward start at the front and the sides; it is recommended that, if the thickness of the starting platform exceeds 0.04 metre, grips of at least 0.1 metre width on each side and 0.4 metre width in the front be cut out to 0.03 metre from the surface of the platform.



Handgrips for the forward start may be installed on the sides of the starting platforms. Handgrips for backstroke starts shall be placed within 0.3 metre to 0.6 metre above the water surface both horizontally and vertically. They shall be parallel to the surface of the end wall and must not protrude beyond the end wall.

A minimum depth of 1.35 metres, extending from 1.0 metre to at least 6.0 metres from the end wall is required for pools with starting blocks. Electronic read-out boards may be installed under the blocks. Flashing is not allowed. Figures must not move during a backstroke start.

16.2.9 Numbering

Each starting block must be distinctly numbered on all four sides, clearly visible. It is recommended that lane number 0 shall be on the right-hand side when facing the course from the starting end with exception of 50m events, which may start from the opposite end. Touch panels may be numbered on the top part.

16.2.10 Backstroke turn indicators

Flagged ropes shall be suspended across the pool, 1.8 metres above the water surface, from fixed standards placed 5.0 metres from each end wall. Distinctive marks must be placed on both sides of the pool, and where possible on each lane rope, 15.0 metres from each end wall.

Flags must be fixed to the ropes having the following dimensions: 0.20 metres on the rope forming a triangle measuring 0.40 metres on the sides. The distance between each flag must be 0.25 metres. If the flags are printed with or support / carry any signage this must be approved in advance by World Aquatics.

16.2.11 Backstroke Ledge

A backstroke ledge may be used:

- The ledge may be adjustable to 4 cm above or 4 cm below the water level.
- The ledge is a minimum of 65 cm in length.
- The ledge must be 8 cm in height, 2 cm at the width with 10 degrees of slope.

See Diagram

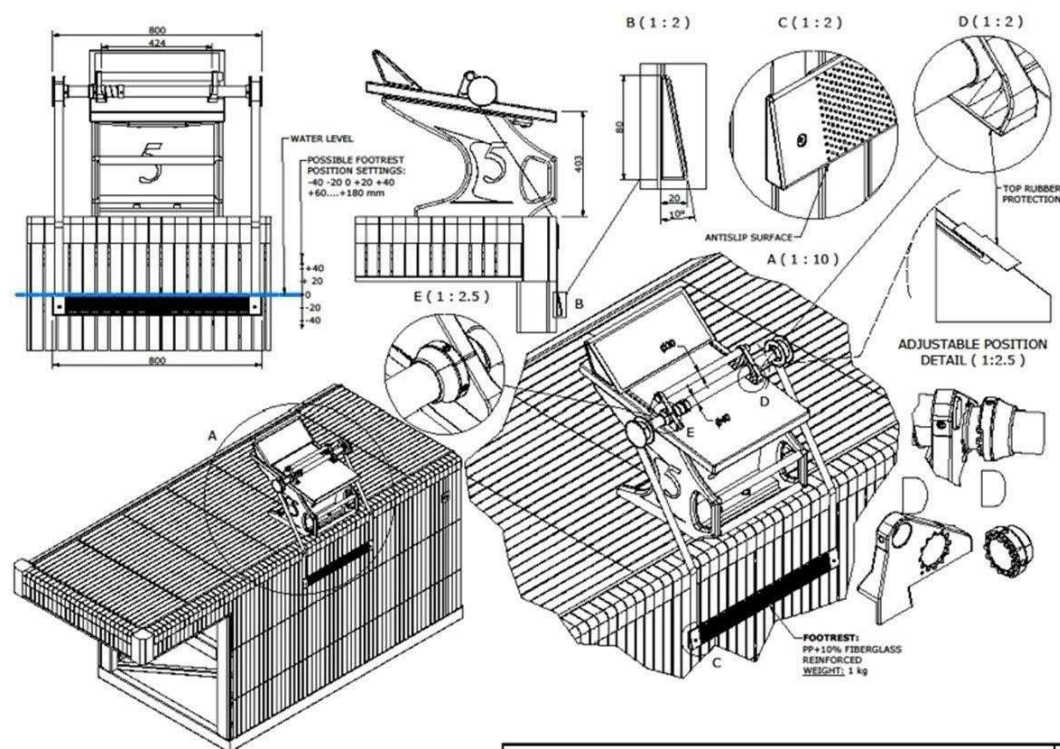

BACKSTROKE LEDGE	
-------------------------	--

16.2.12 False Start Rope

False Start Rope may be suspended across the pool not less than 1.2 metres above the water level from fixed standards placed 15.0 metres in front of the starting end. It shall be attached to the standards by a quick release mechanism. The rope must effectively cover all lanes when activated.

16.2.13 Water conditions
16.2.13.1 Water Temperature

Water temperature shall be 25°C to 28°C.

16.2.13.2 Water Movement

During competition, the water in the pool must be at a constant level, with no appreciable movement.

In order to keep the water level, preserve the transparency of water and take into consideration the health regulations in force in most countries, inflow and outflow has to be regulated as follows:

- 220 to 250 m³/h for 50.00 m pools
- 150 to 180 m³/h for 33.33 m pools
- 120 to 150 m³/h for 25.00 m pools

In daily use, inflow and outflow has to follow the health regulation of each country.

At these turnover rates, the water distribution has to be such that no appreciable current or turbulence is created.

“Appreciable current” is defined as water movement that can move a floating basketball (filled with 6 litres of water to obtain the right buoyancy) in one direction for more than 1,25m in 60 seconds.

The practical way to test this is to install two floating lines crosswise in a swim lane (to obtain a square with 2,5m size, ref. Image 1) and then to leave the basketball in the central point of the square. If the ball does not touch any of the four lane ropes within 60 seconds, the turbulence test is successful.

Test should be repeated in lanes 1,3,6,8 on two sides, at 5m from each end of the pool (end wall or bulkhead).

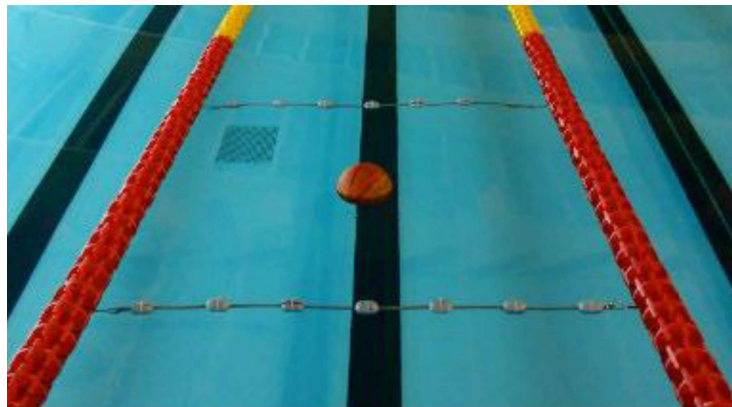

Image 1

16.2.13.3 Salinity of the water

World Records and World Junior Records can be established only in water with less than 3 gr/litre of salt.

No World Records will be recognized in any kind of sea or ocean water.

16.2.14 Lighting

Light intensity over the whole pool shall not be less than 1500 lux.

16.2.15 Lane Markings

Lane Markings shall be of a dark contrasting colour, placed on the floor of the pool in the centre of each lane.

Width: minimum 0.2 metre, maximum 0.3 metre.

Length: 46.0 metres for 50 metre long pools; 21.0 metres for 25 metre long pools.



Each lane line shall end 2.0* metres from the end wall of the pool with a distinctive cross line 1.0 metre long and of the same width as the lane line. The distance between the centre points of each lane shall be 2.5 metres.

*Pool length tolerances must be considered.

Target lines shall be placed on the end walls or on the touch panels, in the centre of each lane, of the same width as the lane lines. They shall extend without interruption from the deck edge (curb), to the floor of the pool to a maximum of 3 metres. A cross line 0.5 metre long shall be placed 0.3 metre below the water surface, measured to the centre point of the cross line.

For 50m and 25m pools constructed after 1st January 2006, cross lines 0.5 metre long shall be placed at the 15 metre mark from each end of the pool. After October 2013 this shall be measured from the end wall to the centre point of the cross line.

16.2.16 Bulkheads

When a bulkhead serves as an end wall, it must extend the full width of the course and present a solid smooth, non-slippery stable vertical surface on which touch pads may be mounted extending not less than 0.8m below and

0.3m above the surface of the water, and must be free of hazardous openings above or below the waterline which may be penetrated by a swimmer's hands, feet, toes or fingers. A bulkhead must be of a design that provides for the free movement of officials along its length without such movement creating any appreciable current or water turbulence.

16.2.17 Minimum distance separating the pools

If the swimming pool and the diving well are in the same area the minimum distance separating the pools shall be 5.0 metres. For pools constructed from 1st January 2014 the minimum distance separating the pool shall be a minimum of 8 metres however 10 metres is preferred.

16.3 Automatic officiating Equipment for Swimming

16.3.1 General description

Automatic and Semi-Automatic Officiating Equipment records the elapsed time of each swimmer and determines the relative place in a race. Judging and timing shall be to 2 decimal places (1/100 of a second). Equipment that is installed shall not interfere with the swimmers' starts, turns, or the function of the overflow system.

16.3.2 Equipment requirements

The Equipment must:

16.3.2.1 Be activated by the starter.

16.3.2.2 Have no exposed wires on the pool deck, if possible.

16.3.2.3 Be able to display all recorded information for each lane by place and by lane.

16.3.2.4 Provide easy digital reading of a swimmer's time.

16.3.3 Starting devices

16.3.3.1 The starter shall have a microphone for oral commands.

16.3.3.2 If a pistol is used, it shall be used with a transducer.

16.3.3.3 Both the microphone and the transducer shall be connected to loudspeakers at each starting block where both the starter's commands and the starting signal can be heard equally and simultaneously by each swimmer.

16.3.3.4 False start detection equipment must be installed.

16.3.4 Touch panels for Automatic Equipment

16.3.4.1 The minimum measurement of the touch panels shall be 2.4 metres wide and 0.9 metre high, and the thickness shall be 0.01m when the contact is closed (and the time is stopped).



They shall extend 0.3 metre above and 0.6 metre below the surface of the water. The equipment in each lane shall be electronically connected independently, so it may be controlled and maintained individually. The surface of the panels shall be of a bright colour and shall bear the line markings approved for the end walls.

16.3.4.2 Installation - The touch panels shall be installed in a fixed position in the centre of the lanes. The panels may be portable, allowing the pool operator to remove them when there are no competitors.

16.3.4.3 Sensitivity - The sensitivity of the panels shall be such that they cannot be activated by water turbulence, but will be activated by a light hand touch. The panels shall be sensitive on the top edge.

16.3.4.4 Markings - The markings on the panels shall conform with and superimpose on the existing markings of the pool. The perimeter and edges of the panels shall be defined by a 0.025 metre black border.

16.3.4.5 Safety - The panels shall be safe from the possibility of electrical shock and shall not have sharp edges.

16.3.5 Semi-Automatic Equipment

With Semi-Automatic Equipment, the finish shall be recorded by buttons pushed by timekeepers at the finish touch of the swimmer.

16.3.5.1 Semi-Automatic Equipment may be used as a backup to the Automatic Officiating Equipment at World Aquatics or other major events if there are three buttons per lane, each operated by a separate official (in which case other finish judges shall not be required). An inspector of turns may operate one of the buttons.

16.3.6 Automatic Equipment – Essential Accessories

The following accessories are essential for a minimum installation of Automatic Equipment:

16.3.6.1 Printout of all information, which can be regenerated during a succeeding race.

16.3.6.2 Spectator readout board.

16.3.6.3 Relay take-off judging to 1/100 of a second. Where overhead video cameras are installed they may be reviewed as a supplement to the automatic system's judgement of relay take-off. For the differential in the relays take-off the manufacturer of the device shall be consulted.

16.3.6.4 Automatic lap counter.

16.3.6.5 Readout of splits.

16.3.6.6 Computer summaries.

16.3.6.7 Correction of erroneous touch.

16.3.6.8 Automatic rechargeable battery operation possibility.

16.3.7 Automatic Equipment – Accessories for Olympic Games and World Aquatics Championships

For Olympic Games and World Aquatics Championships the following accessories are also essential:

16.3.7.1 The spectator electronic read-out board shall contain at least twelve (12) lines of thirty-two (32) characters, each capable of displaying both letters and numbers. Each character shall have a minimum height of 360 mm. Each line – matrix scoreboard shall be able to scroll up or down, with blink function, and each full matrix scoreboard shall be programmable, and capable of showing animation. The board must have a minimum size of 7.5 m width by 4.5m height.

16.3.7.2 There shall be an air-conditioned control room, with dimensions of a least 6.0 metres x 3.0 metres, located between 3.0 metres and 5.0 metres from the finish wall, with an unobstructed view of the finish wall at all times during the race. The referee must have easy access to the control centre during the competition. At all other times the control room shall be able to be secured.

16.3.7.3 Video judging and timing.

16.3.8 Timing room

Timekeepers shall have a clear view on the finish pool side from the Timing room. Sponsor panels or LED wall shall be installed at a minimum of 2m distance from the finish wall Timing room side. The panels or LED wall shall not exceed the length of 46m.



See Diagram

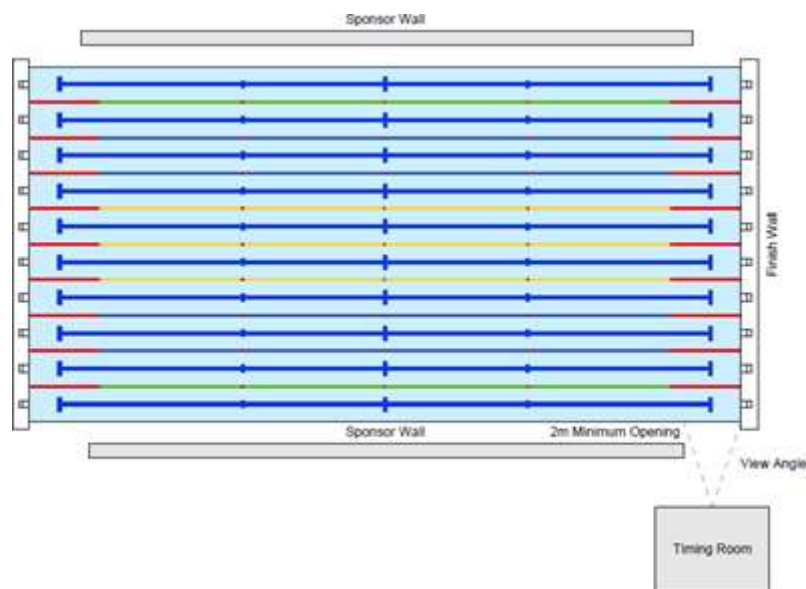

16.3.9 Video Judging Equipment

At Olympic Games and World Championships approved Automatic Officiating Equipment, including Video Judging Equipment shall be provided and used. The approved Video Judging Equipment shall be used to initiate stroke infraction calls, confirm stroke infraction calls or assist the Referee to overturn calls made on the pool deck.

17 MEDICAL AND SAFETY SPECIFIC REQUIREMENTS FOR SWIMMING

The Medical Requirements are described in the Part One, Article 9.2. However, each sport has unique components.

17.1 Pre-competition trainings

Swimming competitions are generally composed of two competition sessions: one in the morning and one in the afternoon/evening. Prior to the races, the swimmers will be present at the venue to train. They generally arrive 2.5 - 3 hours before the beginning of the competition. It implies that an important number of athletes are swimming but also walking around the pool, and exercising/stretching. This proximity can lead to collisions in and out of the water.

Pre-competition training is a critical period as numerous swimmers in the pool are training at the same time and are practising various elements of their race (e.g the start) or are swimming different strokes. While lanes are dedicated to each practice, accident/collision can occur.

In addition, at major events, the numbers of swimmers in the warm-up pool area could be particularly high. The numbers of lifeguards shall therefore be adjusted to appropriately cover the different swimming pools.

17.2 Location of the FoP First Aid Treatment Area

Ideally, for the competition pool, the Field of Play (FoP) First Aid Treatment Area should be positioned where the athletes exit the water without obstructing the mixed zone on the pool deck.

17.3 Water Rescue and Lifeguards

Lifeguards should practice water retrieval on a daily basis during the event. In Swimming, it is important to remember that the swimming pools are separated by the lane ropes that could block the access to the swimmer during the water rescue. This point must be taken into consideration while practising and the extraction point should be adjusted.

It is recommended to have three (3) lifeguards by swimming-pool. Two lifeguards next to the FoP Treatment area and a third lifeguard positioned on the opposite side.

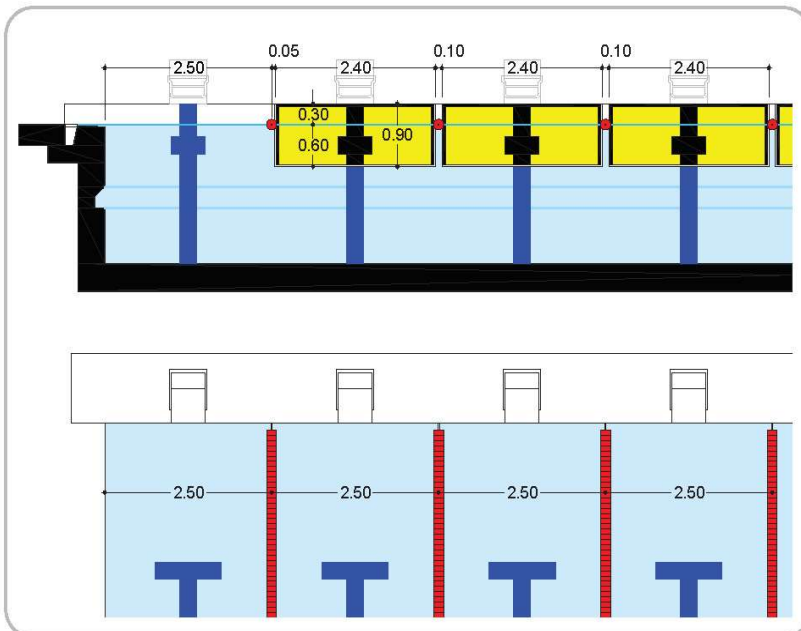
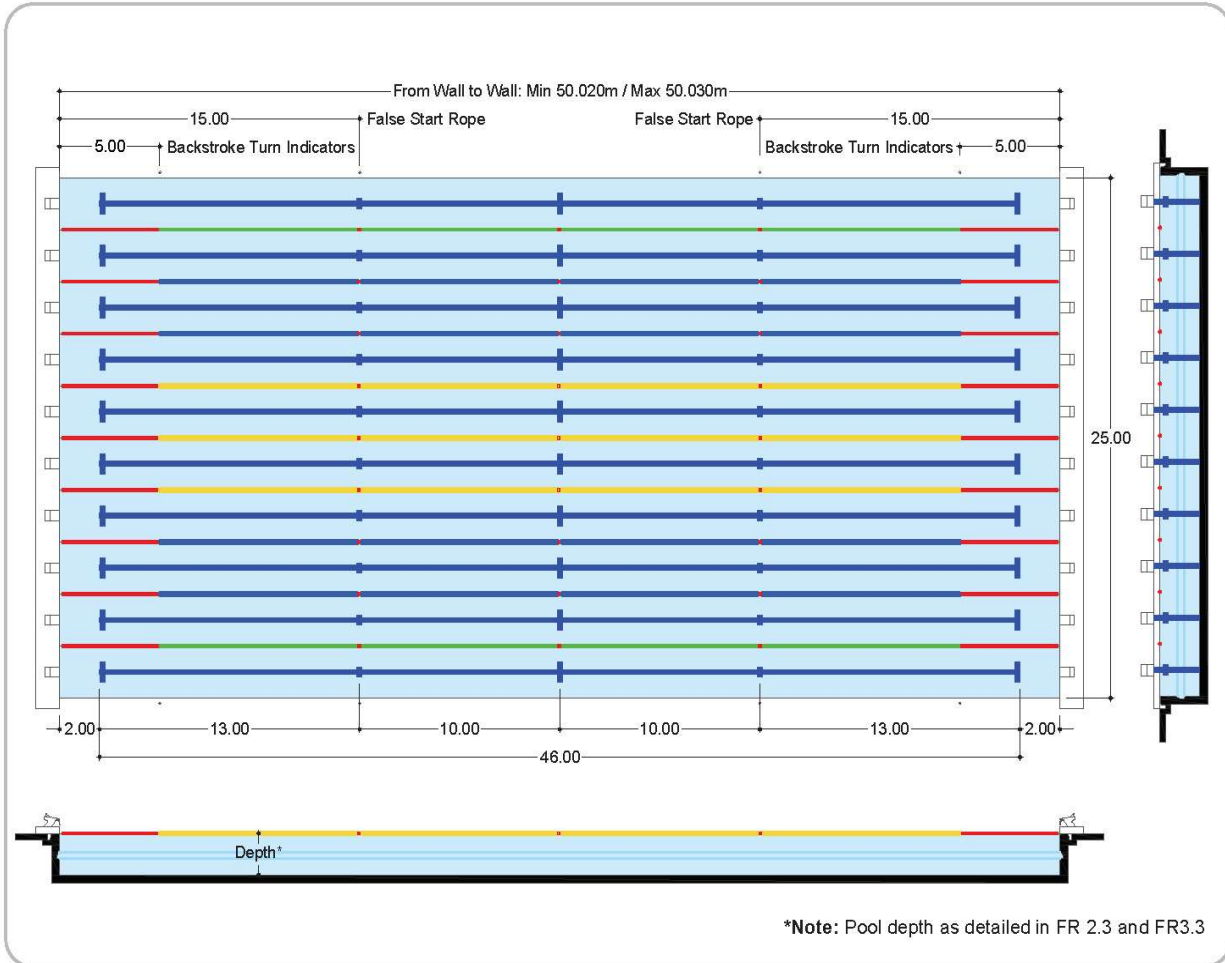
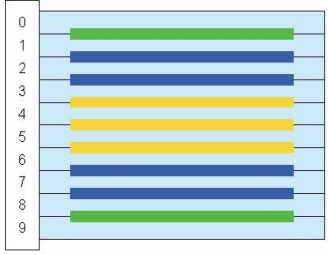

ANNEX 1 – Diagram Swimming Pool 50x25m – 8 Lane

Lane Ropes

In a 8 (eight) lanes swimming pool the colour of the lane ropes should be as follows:

- Two (2) GREEN ropes for lanes 1 and 8.
- Four (4) BLUE ropes for lanes 2, 3, 6 and 7.
- Three (3) YELLOW ropes for lanes 4, 5.



ANNEX 2 – DIAGRAM SWIMMING POOL 50X25m – 10 Lanes

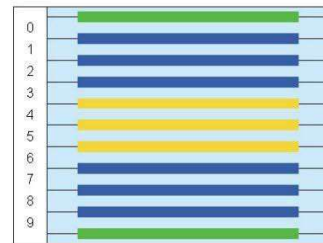
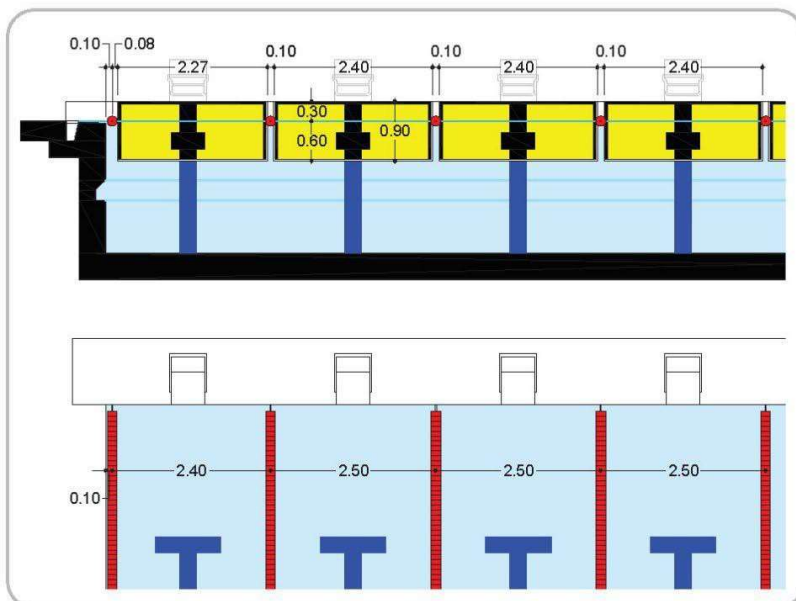
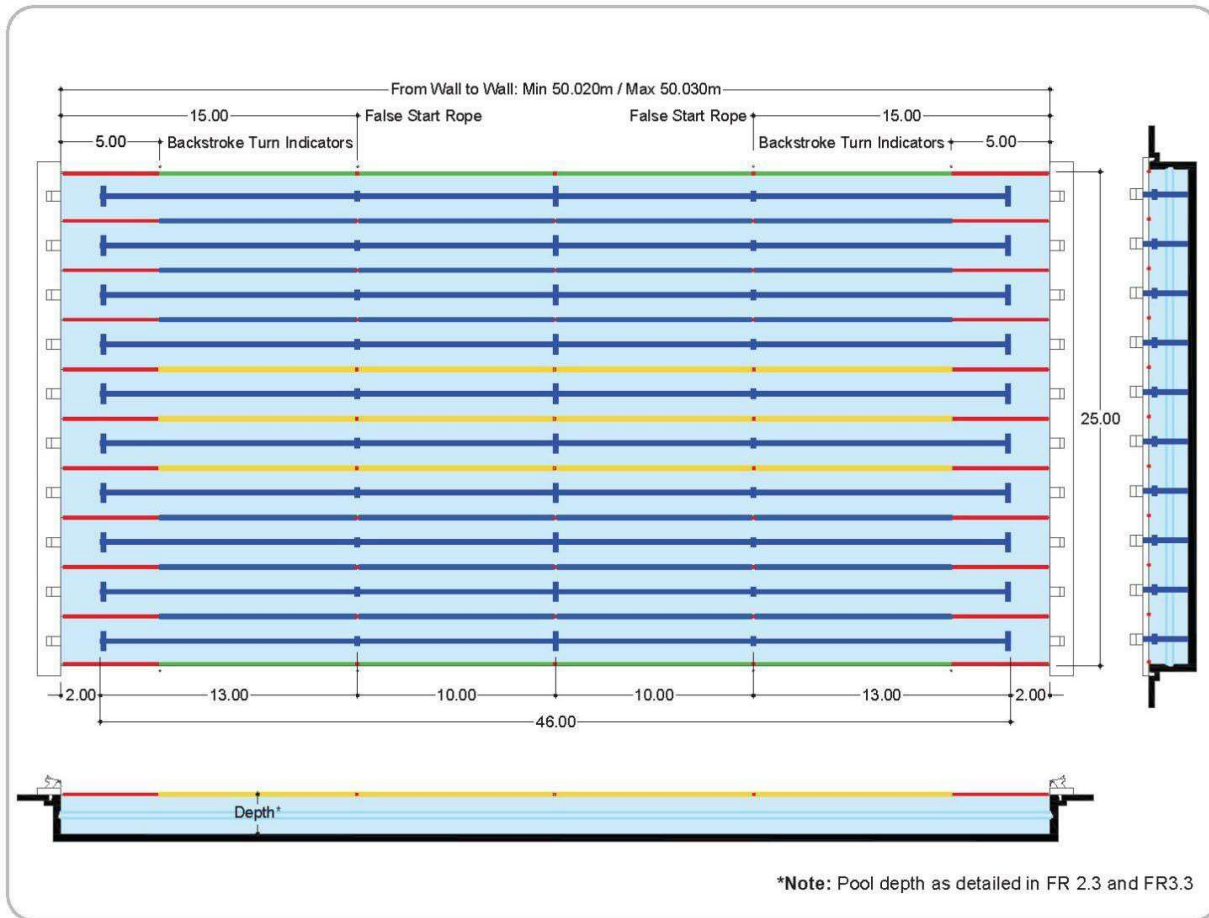

Lane Ropes

In a 10 (ten) lanes swimming pool the colour of the lane ropes should be as follows:

- Two (2) GREEN ropes for lanes 0 and 9.
- Six (6) BLUE ropes for lanes 1, 2, 3, 6, 7 and 8.
- Three (3) YELLOW ropes for lanes 4, 5.



ANNEX 3 – DIAGRAM SWIMMING POOL 50X25m – 10 Lanes

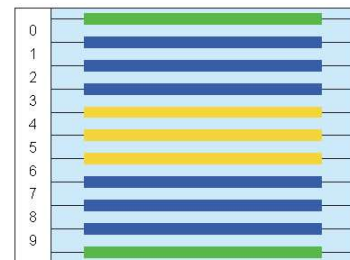
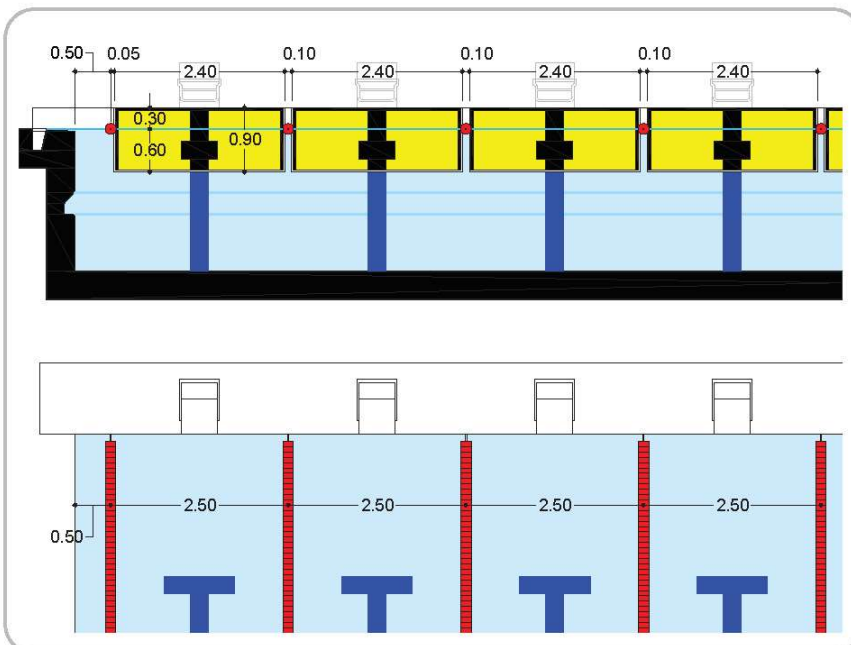
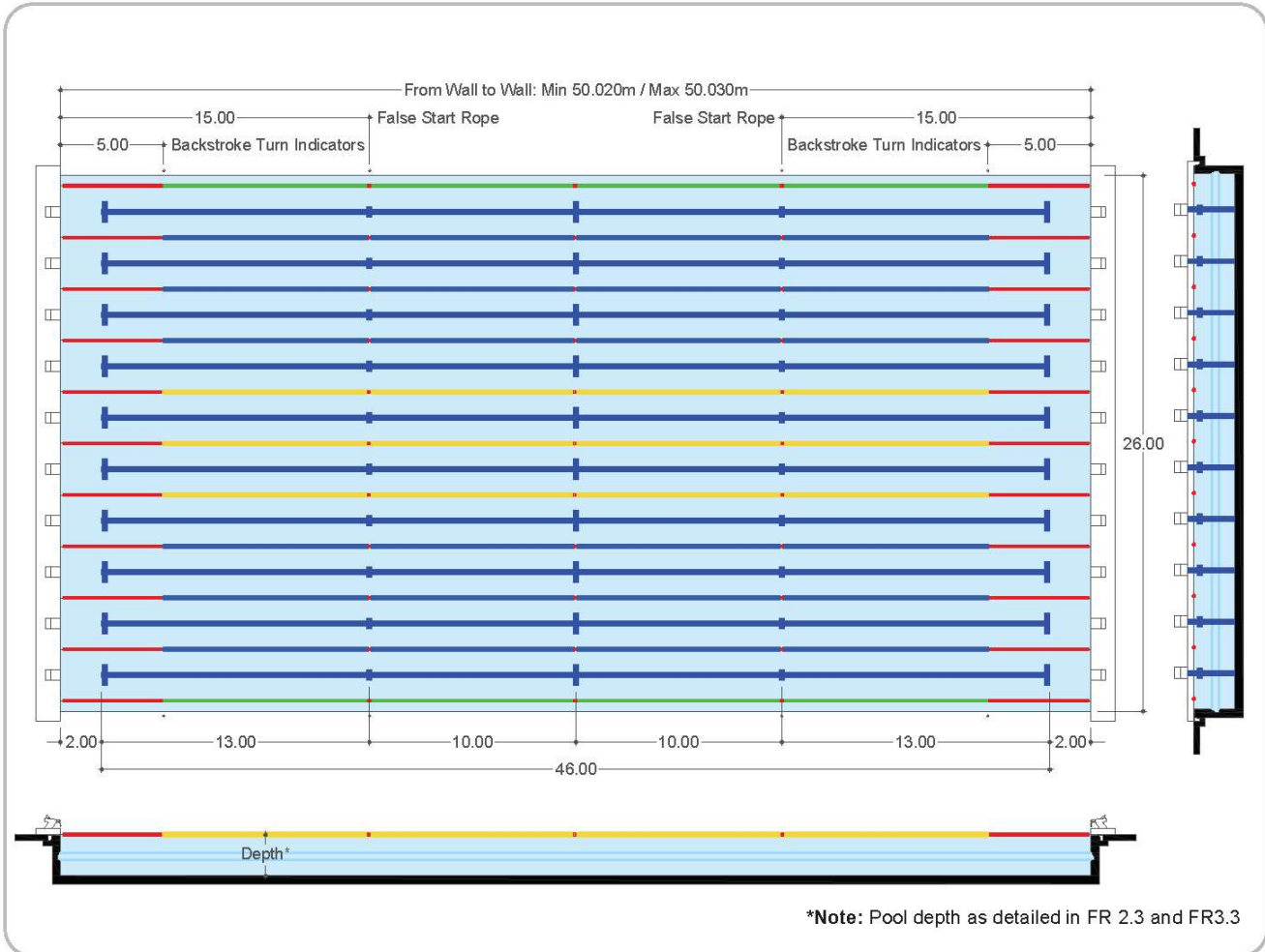

Lane Ropes

In a 10 (ten) lanes swimming pool the colour of the lane ropes should be as follows:

- Two (2) GREEN ropes for lanes 0 and 9.
- Six (6) BLUE ropes for lanes 1, 2, 3, 6, 7 and 8.
- Three (3) YELLOW ropes for lanes 4, 5.

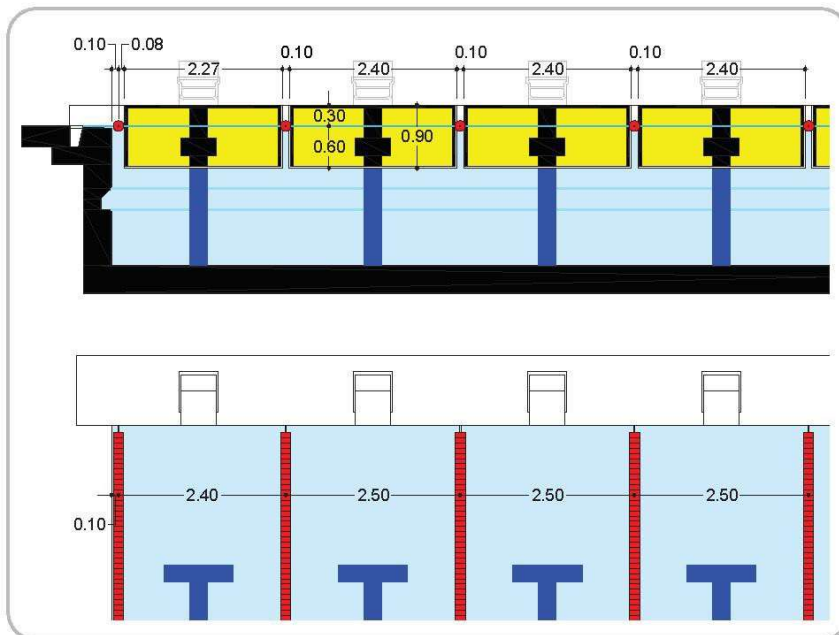
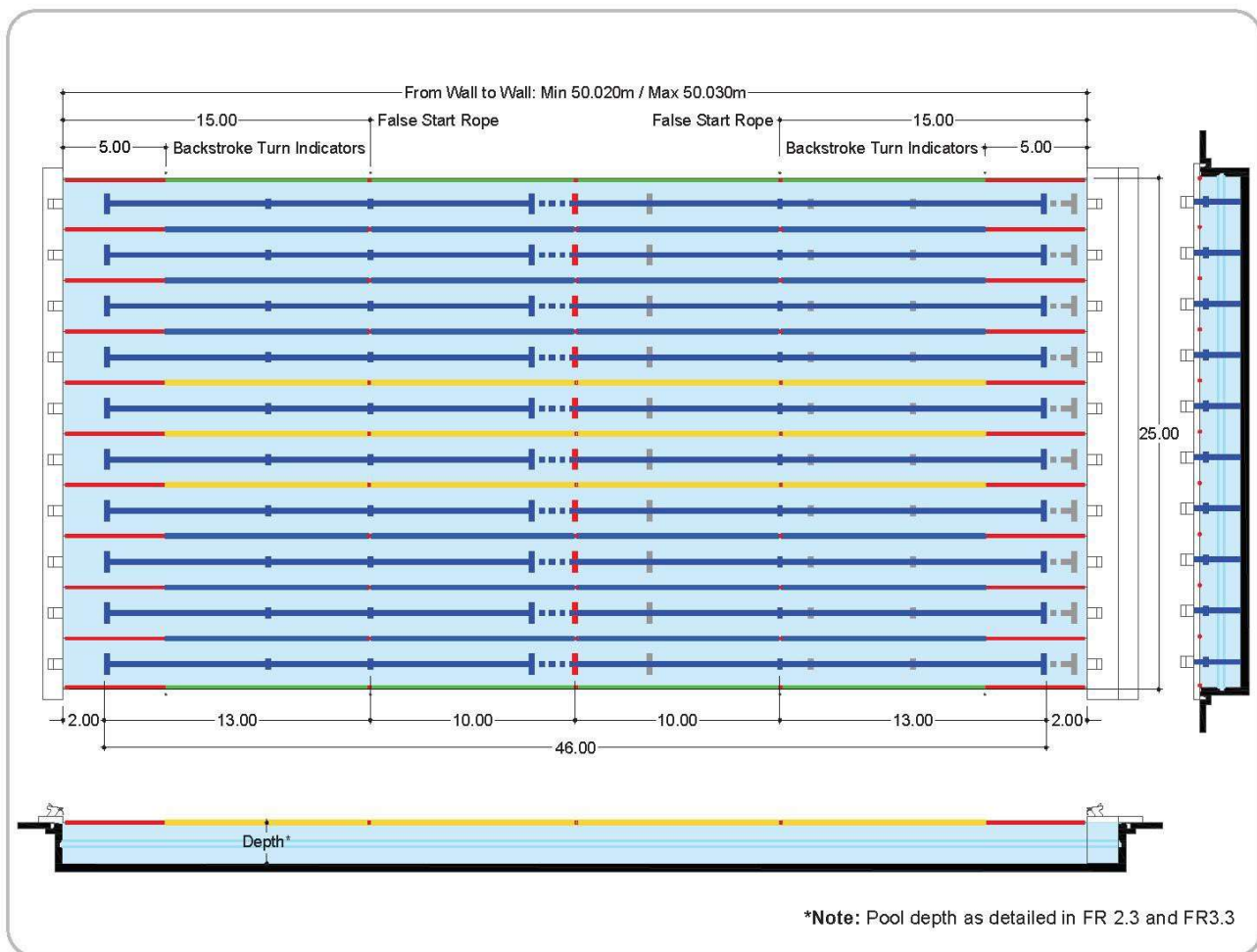
ANNEX 4 – DIAGRAM SWIMMING POOL 50X25 WITH ONE BULKHEAD IN LATERAL POSITION

Lane Ropes

In a 10 (ten) lanes swimming pool the colour of the lane ropes should be as follows:

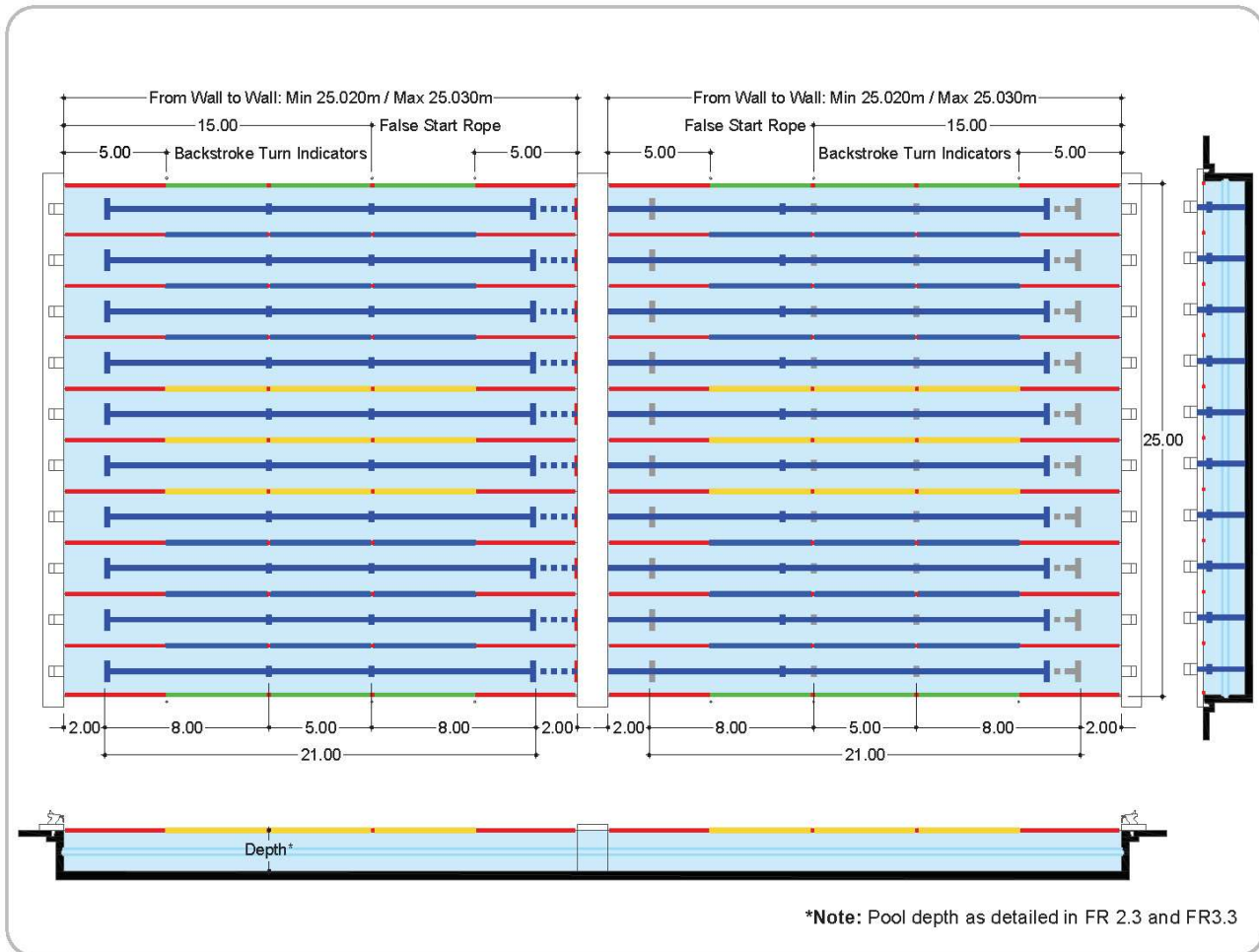
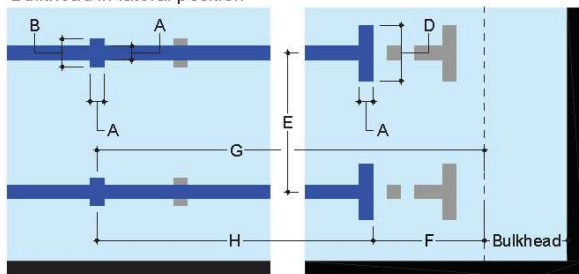
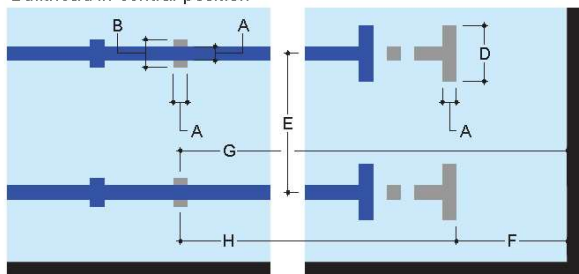
- Two (2) GREEN ropes for lanes 0 and 9.
- Six (6) BLUE ropes for lanes 1, 2, 3, 6, 7 and 8.
- Three (3) YELLOW ropes for lanes 4, 5.



ANNEX 5 – DIAGRAM SWIMMING POOL 50X25M WITH ONE BULKHEAD –BULKHEAD IN CENTRAL POSITION

Bulkhead in lateral position

Bulkhead in central position

Lane Markings

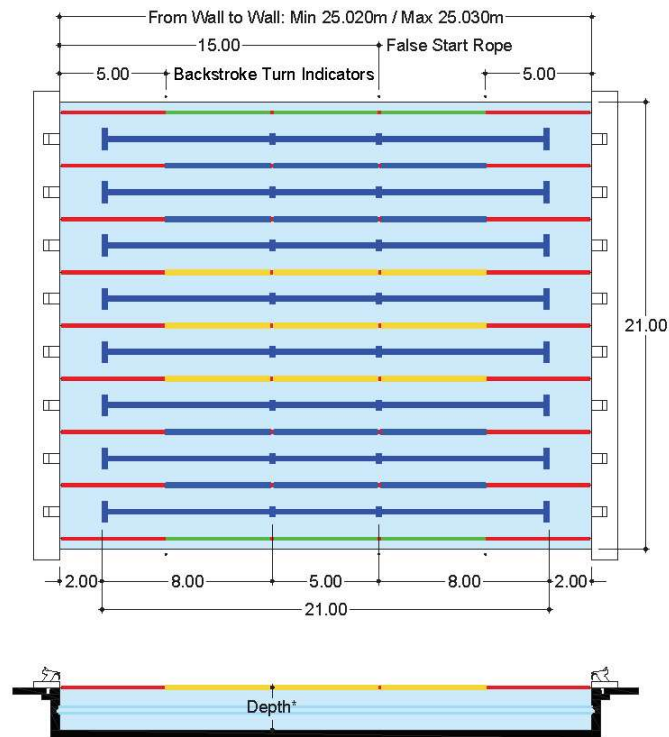
Width of lane markings, end, lines targets	A	0.25m ± 0.05m
Length of end wall targets	B	0.50m
Depth to centre of end wall targets	C	0.30m
Length of lane marker cross line	D	1.00m
Width of racing lanes	E	2.50m
Distance from end of lane line to end wall	F	2.00m*
Distance from centre of cross line to end wall	G	15.00m*
Distance from end of lane line to centre of cross line	H	13.00m
Distance from centre of cross line to end wall	I	25.00m*

** Pool tolerance has to be considered*



ANNEX 6 – DIAGRAM SWIMMING POOL 25X21M – 8 Lanes



*Note: Pool depth as detailed in FR 2.3 and FR3.3

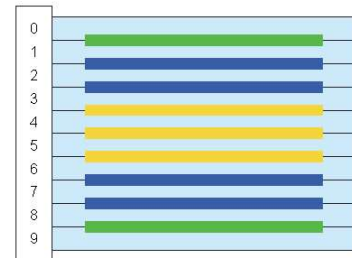
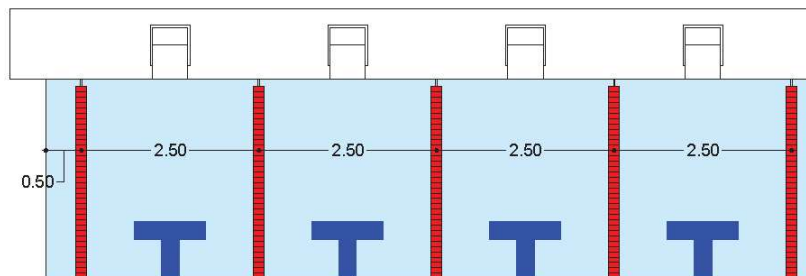
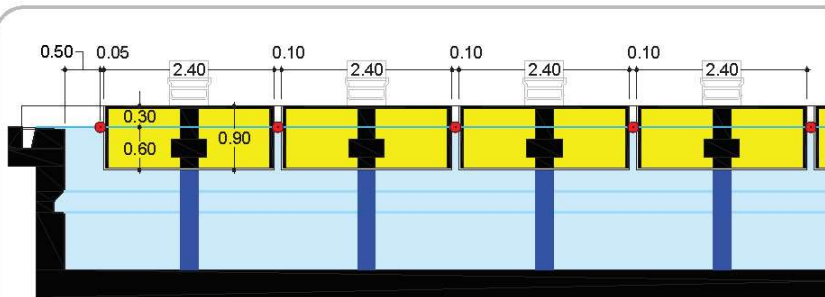

Lane Ropes

In a 8 (eight) lanes swimming pool the colour of the lane ropes should be as follows:

- Two (2) GREEN ropes for lanes 1 and 8.
- Four (4) BLUE ropes for lanes 2, 3, 6 and 7.
- Three (3) YELLOW ropes for lanes 4, 5.



ANNEX 7 – DIAGRAM SWIMMING POOL 25X21M – 8 Lanes

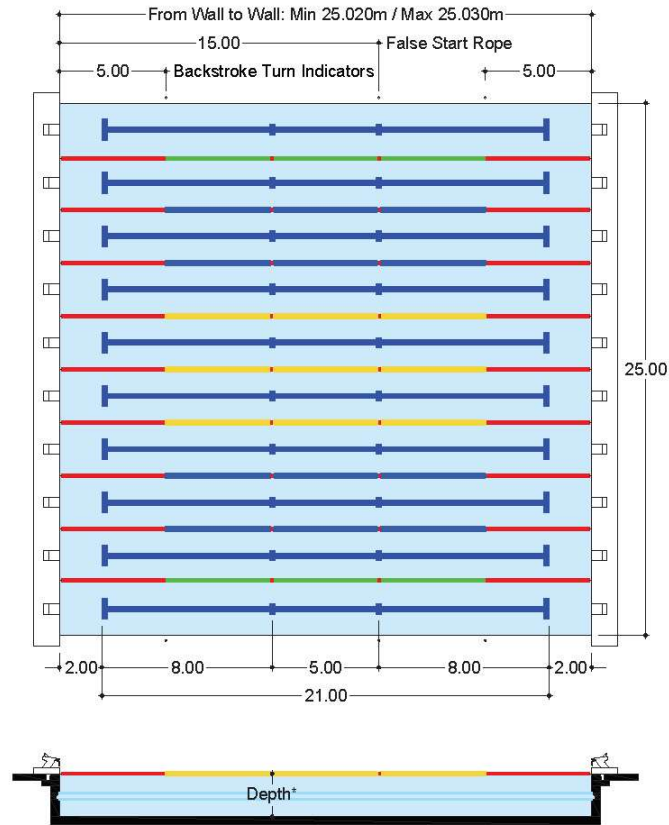

*Note: Pool depth as detailed in FR 2.3 and FR3.3

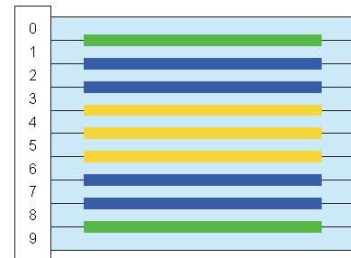
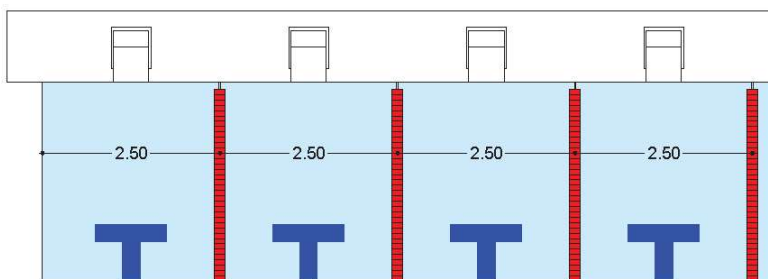
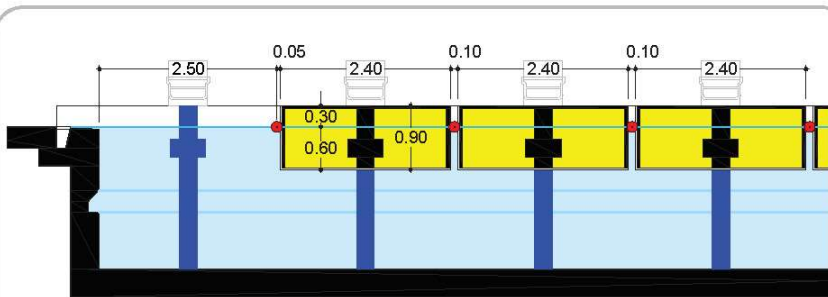

Lane Ropes

In a 8 (eight) lanes swimming pool the colour of the lane ropes should be as follows:

- Two (2) GREEN ropes for lanes 1 and 8.
- Four (4) BLUE ropes for lanes 2, 3, 6 and 7.
- Three (3) YELLOW ropes for lanes 4, 5.

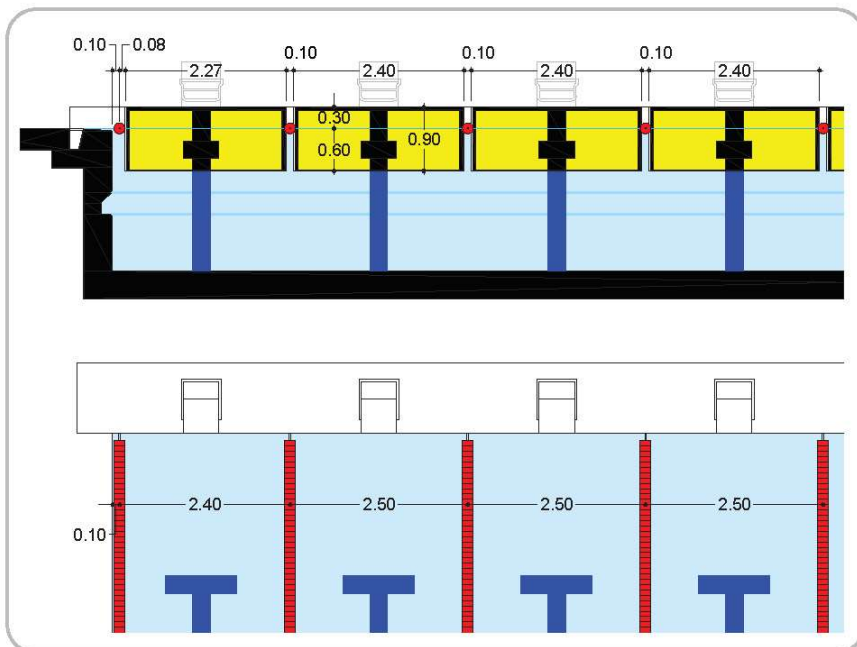
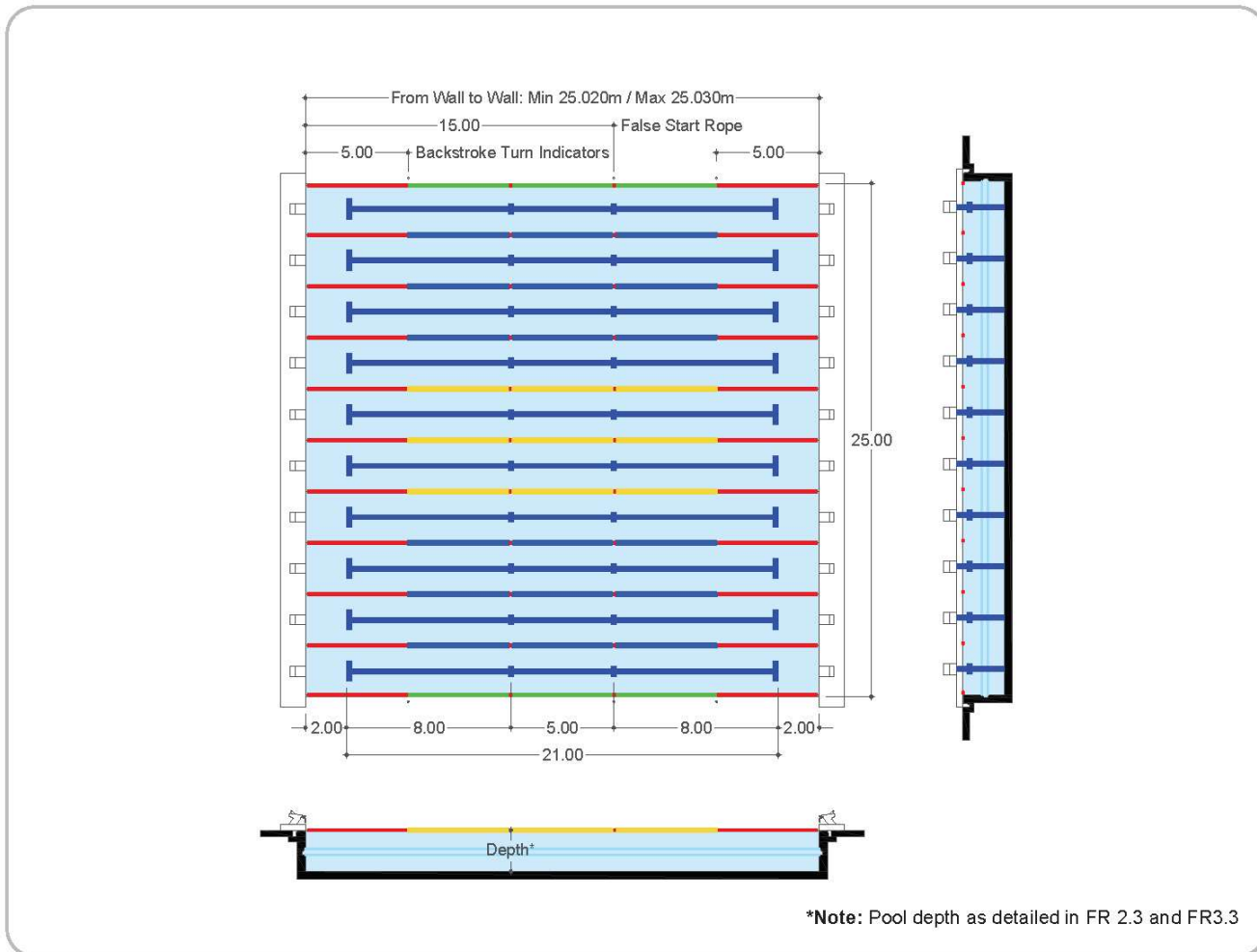
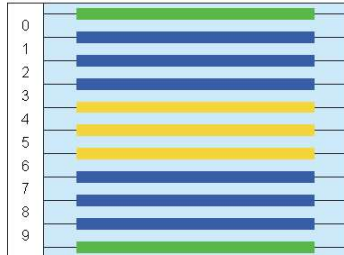

ANNEX 8 - DIAGRAM SWIMMING POOL 25X25M – 10 Lanes

Lane Ropes

In a 10 (ten) lanes swimming pool the colour of the lane ropes should be as follows:

- Two (2) GREEN ropes for lanes 0 and 9.
- Six (6) BLUE ropes for lanes 1, 2, 3, 6, 7 and 8.
- Three (3) YELLOW ropes for lanes 4, 5.

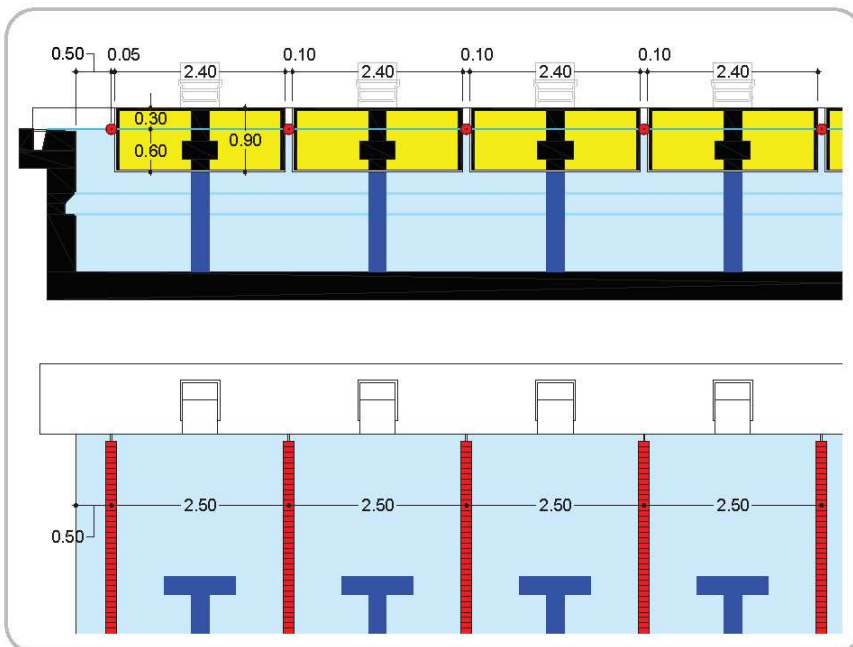
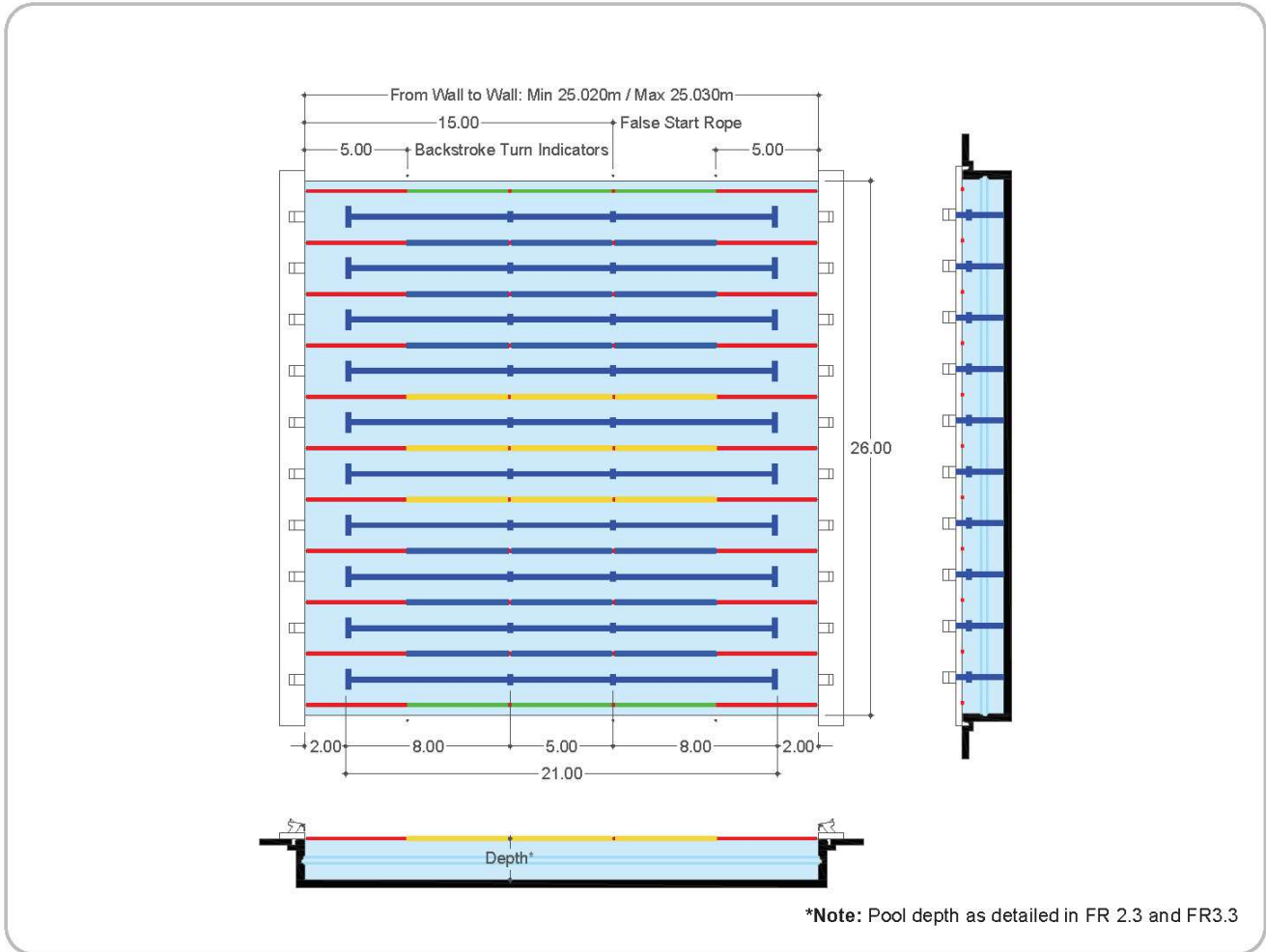
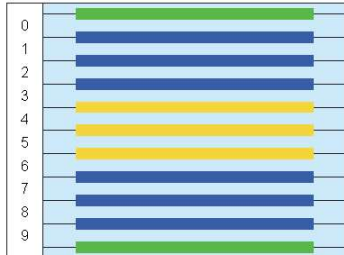

ANNEX 9 - DIAGRAM SWIMMING POOL 25X26M – 10 Lanes

Lane Ropes

In a 10 (ten) lanes swimming pool the colour of the lane ropes should be as follows:

- Two (2) GREEN ropes for lanes 0 and 9.
- Six (6) BLUE ropes for lanes 1, 2, 3, 6, 7 and 8.
- Three (3) YELLOW ropes for lanes 4, 5.

ANNEX 10 - DIAGRAM 50m SWIMMING POOL – Lane markings

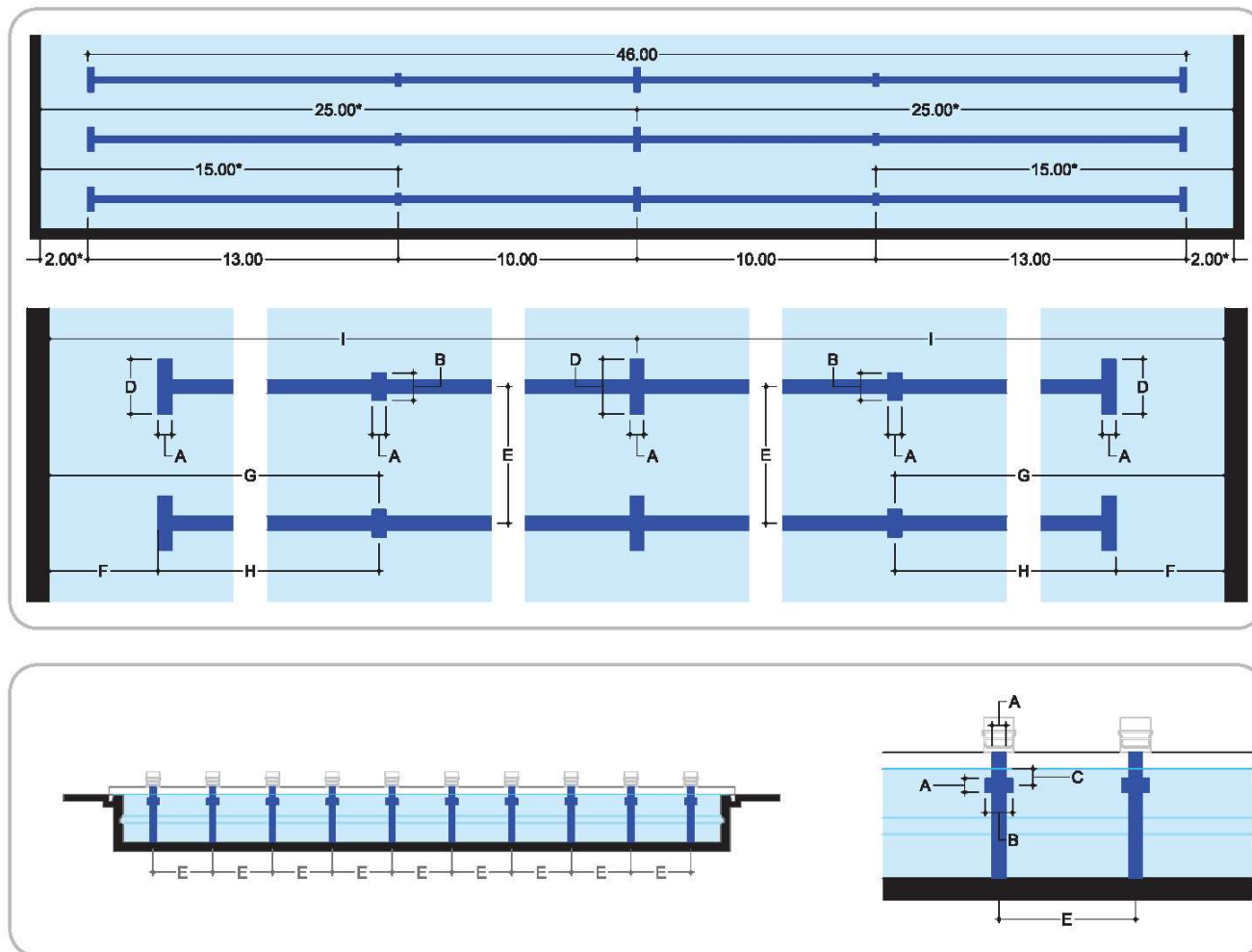
Lane Markings

Width of lane markings, end, lines targets	A	0.25m ± 0.05m
Length of end wall targets	B	0.50m
Depth to centre of end wall targets	C	0.30m
Length of lane marker cross line	D	1.00m
Width of racing lanes	E	2.50m
Distance from end of lane line to end wall	F*	2.00m*
Distance from centre of cross line to end wall	G	15.00m*
Distance from end of lane line to centre of cross line	H	13.00m
Distance from centre of cross line to end wall	I	25.00m*

* Pool tolerance has to be considered